

UPDATED 29/01/2021 Please be aware prices can fluctuate throughout the year

PRODUCT DESCRIPTION

A

ABRAFILE

ABRASIVES

ABRASIVE PAPER DISCS (METALLURGY)

ACRYLIC SHEET AND ROD

ADHESIVE TAPES

ADHESIVES GLUE/SEALANTS

ADJUSTABLE SPANNERS

AEROSOL PAINTS

AIRLINE AND FITTINGS

ALLUMINIUM SHEET/FLAT/ROUND/ANGLE/SQUARE

ALLEN KEYS

ASSORTED PINS/CLIPS/O-RINGS

ATTOMISER SPRAY BOTTLE

B

BAGS VARIOUS SIZE (SAMPLE BAGS)

BALSA WOOD

BANDSAW BLADES

BARRIER CREAM

BATTERIES

BENCH/FLOOR BRUSHES

BLEED PROOF PADS

BOLTS

BOTTLES GLASS/PLASTIC

BRASS ROUND AND FLAT

BRIGHT DRAWN MILD STEEL

BRUSHES PAINT

BUMPER ROLL / TORK ROLL

C

CARD (ARCHITECTURE STUDENTS)

CASTROL OIL

CHAIN

CIRCLIPS

CLAMPS

CLEANERS

COACH BOLTS

COMPRESSION SPRINGS

COPPER GREASE

COPPER Mallet

CUTTING FLUIDS AND COMPOUNDS

CUTTING TOOLS (MACHINE)

D

DEGREASER

DIES METRIC/IMPERIAL

DIGITAL CALIPER

DREMEL

DOUBLE BUBBLE EPOXY

DRILLS SET

DRILL AND TAP SPRAY

DRY WIPE BOARD

DUST MASK

E

EAR DEFENDERS AND PLUGS

END MILLS

ELECTRODE PIPE

ENGINEERS INK

ENGINEERS REF BOOK

EXPANDING FOAM

EVOSTIK

EYE PROTECTION

EN24 STEEL

F

FACE FIT TEST KIT

FIXINGS / FASTENERS-SOCKET CAPS-HEX HEADS-WASHERS-NUTS

FELT NOTICE BOARD

FILES AND HANDLES

FILLER

FILAMENT (PLA) 3D PRINTING

FLAP WHEELS

FLASH DRIVE / USB PEN DRIVES / MICRO SD CARD

FLUX

G

GAFFER TAPE

GLASSWARE

GREASES

GRINDING DISCS

GROUND FLAT STOCK

H

HACKSAW BLADES

HACKSAW FRAME

HAMMERITE PAINT/THINNERS

HAND PROTECTION

HAND TOOLS

HAND WIPES

HEAT RESISTANT TAPE/ POLYIMIDE TAPE

HELICOILS

HEX HEAD SETSCREWS

HEX HEAD BOLTS

HINGES

HOLESAW

HOSE

I

INK ENGINEERS

INSERTS CUTTING

IRONMONGERY

INSULATION FOR PIPE

J

JIGSAW BLADES

JOINTING COMPOUND

JUNIOR HACKSAW BLADE

JUBILEE CLIPS

K

KEYBOARD & MOUSE

KNIFE BLADE

KNIFE (UTILITY)

L

LABCOATS

LEAK DETECTOR

LETRASET PENS

LINISHER BELT

LOCTITE PRODUCTS

LUBRICANT SPRAYS

M

MASKING TAPE

METALLURGY PRODUCTS

MIG WIRE

MILD STEEL ANGLE

MILD STEEL SHEET AND BAR

MILD STEEL TUBE

MOLE GRIPS

MUDGAURD WASHER

N

NAILS

NITRILE GLOVES

NUTS AND NUTCERTS

NYLATRON ROD

O

OCLIPS

ORINGS

OVERSPEC

P

PADLOCKS

PAINTS

PAINT BRUSHES

PAXOLIN BOARD

PNEUMATIC TUBE AND CONSUMABLES

PVC TUBING

R

RAWLPLUGS

REFUSE BAGS

RULE

RIVETS

S

SAFETY EQUIPMENT

SAMPLE BOXES

SCREWED ROD

SEALANTS

SILVER STEEL

SOLDER

STAINLESS STEEL SHEET AND BAR

STEEL BALLS

T

TAPS

TENSION SPRING

TERRY CLIP

TOOLS

TORCHES

TREFOLEX

V

VERNIER CALIPERS

VDU CLEANER

W

WASHERS VARIOUS

WATER CONTAINER

WD40

WELDING WIRE

WET AND DRY

WIPERS

WIRE BRUSH

WOODSCREWS

ELECTRICAL INDEX

Code Product

V01 SINGLE TRI-RATED CABLE

V02 FLEXIBLE MAINS CABLE

V03 FLEX ARMOURED SY / YY CABLE

V04 LSF CABLE

V05 MISCELLANEOUS CABLE

V06 20mm CONDUIT & ACCESSORIES

V07 25mm CONDUIT & ACCESSORIES

V08 INSULATED CABLE CRIMP

V09 UNINSULATED CABLE CRIMP

V10 FUSE & CARRIERS

V11 CABLE CLIPS & TIES

V12 LAMPS & LAMP HOLDERS

V13 CABLE GLANDS

V14 INSULATION TAPE

V15 TERMINAL BLOCKS

V16 PVS TRUNKING, GALVANISED CHANNEL & ACCESSORIES

V17 CONDUIT FITTINGS & REDUCERS

V19 SURFACE BOXES & PLASTIC PLATES

V20 METAL CLAD SURFACE BOXES & PLATES

V21 FLEXIBLE ARMD CONDUIT & FITTINGS

V22 VERIFLEX & KOPEX ACCESSORIES

V23 SINGLE & 3-PHASE SOCKET CONNECTORS

V24 MOELLER EQUIPMENT & CONTRACTORS

V26 ADAPTABLE BOXES

V30 MISCELLANEOUS ELECTRICAL ITEMS

V39 4mm CONNECTORS

V40 JACK PLUGS & SOCKETS

V42 SOLDERING ITEMS

V48 BOOTLACE FERRULES

V49 DIN RAIL & ACCESSORIES

V52 SCHNEIDER PRODUCTS

<u>Code</u>	<u>Product</u>	<u>Unit</u>	<u>Std. cost</u>	
A	FERROUS MATERIALS			
<u>MJ-A01</u>	<u>MILD STEEL & GALVANISED SHEET</u>			
MJ-A01002	0.8mm SHEET STEEL (22swg appx)	SQM	£7.92	
MJ-A01004	1.0mm SHEET STEEL (20swg appx)	SQM	£15.55	
MJ-A01006	1.2mm SHEET STEEL (18swg appx)	SQM	£17.71	
MJ-A01008	1.6mm SHEET STEEL (16swg appx)	SQM	£20.21	
MJ-A01010	2.0mm SHEET STEEL (14swg appx)	SQM	£31.32	
MJ-A01014	3.0mm MILD STEEL PLATE	SQM	£50.40	
MJ-A01020	1.6mm GALVANISED SHEET	SQM	£20.30	
MJ-A01021	2.0mm (2500 x 1250mm) GALVANISED SHEET	SQM	£33.03	

**MJ-A02****ROUND BDMS- METRIC**

MJ-A02001	3mm dia. ROUND BDMS	M	£1.03	
MJ-A02002	4mm dia. ROUND BDMS	M	£0.86	
MJ-A02003	5mm dia. ROUND BDMS	M	£0.83	
MJ-A02004	6mm dia. ROUND BDMS	M	£1.21	
MJ-A02005	8mm dia. ROUND BDMS	M	£1.16	
MJ-A02006	10mm dia. ROUND BDMS	M	£1.64	
MJ-A02007	12mm dia. ROUND BDMS	M	£2.16	
MJ-A02008	16mm dia. ROUND BDMS	M	4.00	
MJ-A02010	20mm dia. ROUND BDMS	M	£6.22	
MJ-A02011	25mm dia. ROUND BDMS	M	£8.46	
MJ-A02012	28mm dia. ROUND BDMS	M	£10.45	



MJ-A02013	30mm dia. ROUND BDMS	M	£12.61	
MJ-A02014	32mm dia. ROUND BDMS	M	£14.98	
MJ-A02015	40mm dia. ROUND BDMS	M	£19.50	
MJ-A02020	50mm dia. ROUND BDMS	M	£31.97	
MJ-A02022	60mm dia. ROUND BDMS	M	£37.15	
MJ-A02025	65mm dia. ROUND BDMS	M	£52.08	
MJ-A02030	75mm dia. ROUND BDMS	M	£66.52	
MJ-A02040	100mm dia. ROUND BDMS	M	£124.41	
MJ-A02050	140mm dia. ROUND BDMS	M	£238.46	

MJ-A03 **ROUND BDMS - IMPERIAL**

Code	Product	Unit	Std. cost	
MJ-A03035	2 1/8 dia ROUND BDMS (RUNNING DOWN)	M	35.95	
MJ-A03037	2 1/4 dia ROUND BDMS (RUNNING DOWN)	M	49.99	



MJ-A03043	2 3/4" dia. ROUND BDMS (RUNNING DOWN)	M	65.33	
MJ-A03048	3 1/2" dia. ROUND BDMS	M	93.31	
MJ-A03050	3 3/4" dia. ROUND BDMS	M	112.32	
MJ-A03053	4 1/2" dia. ROUND BDMS	M	146.48	
MJ-A03054	4 3/4" dia. ROUND BDMS	M	216.00	
MJ-A03059	5 1/2" dia. ROUND BDMS	M	238.46	
MJ-A03060	6 " dia. ROUND BDMS	M	297.21	

MJ-A04 **BDMS FLAT - METRIC**

MJ-A04000	3 x 16mm FLAT BDMS	M	3.56	
MJ-A04001	3 x 20mm FLAT BDMS	M	3.26	
MJ-A04002	3 x 25mm FLAT BDMS	M	3.43	
MJ-A04003	3 x 30mm FLAT BDMS	M	3.02	
MJ-A04004	3 x 40mm FLAT BDMS	M	4.64	
MJ-A04005	3 x 50mm FLAT BDMS	M	4.32	
MJ-A04007	3 x 100mm FLAT BDMS	M	9.74	



MJ-A04008	3 x 150mm FLAT BDMS	M	12.44	
MJ-A04009	5 x 12mm FLAT BDMS	M	3.02	
MJ-A04010	5 x 16mm FLAT BDMS	M	3.97	
MJ-A04011	5 x 20mm FLAT BDMS	M	5.01	
MJ-A04012	5 x 25mm FLAT BDMS	M	4.52	
MJ-A04013	5 x 30mm FLAT BDMS	M	4.07	
MJ-A04015	5 x 40mm FLAT BDMS	M	5.87	
MJ-A04016	5 x 50mm FLAT BDMS	M	7.19	
MJ-A04017	6 x 12mm FLAT BDMS	M	4.66	
MJ-A04018	6 x 20mm FLAT BDMS	M	3.51	
MJ-A04019	6 x 25mm FLAT BDMS	M	4.49	



MJ-A04020	6 x 30mm FLAT BDMS	M	5.53	
MJ-A04021	6 x 40mm FLAT BDMS	M	4.91	
MJ-A04022	6 x 45mm FLAT BDMS	M	8.64	
MJ-A04023	6 x 50mm FLAT BDMS	M	8.38	
MJ-A04024	6 x 60mm FLAT BDMS	M	7.77	
MJ-A04025	6 x 70mm FLAT BDMS	M	10.60	
MJ-A04026	6 x 75mm FLAT BDMS	M	11.31	
MJ-A04027	6 x 100mm FLAT BDMS	M	13.82	
MJ-A04028	6 x 125mm FLAT BDMS	M	22.39	
MJ-A04029	6 x 150mm FLAT BDMS	M	27.64	
MJ-A04030	8 x 25mm FLAT BDMS	M	5.70	



MJ-A04030A	8 x 30mm FLAT BDMS	M	7.60	
MJ-A04031	8 x 40mm FLAT BDMS	M	7.48	
MJ-A04032	8 x 75mm FLAT BDMS	M	17.28	
MJ-A04032A	8 x 100mm FLAT BDMS	M	15.38	
MJ-A04033	10 x 25mm FLAT BDMS	M	5.18	
MJ-A04034	10 x 30mm FLAT BDMS	M	5.35	
MJ-A04035	10 x 40mm FLAT BDMS	M	7.14	
MJ-A04036	10 x 50mm FLAT BDMS	M	10.28	
MJ-A04037	10 x 65mm FLAT BDMS	M	15.20	
MJ-A04038	10 x 75mm FLAT BDMS	M	16.69	
Code	Product	Unit	Std. cost	



MJ-A04039	10 x 100mm FLAT BDMS	M	21.17	
MJ-A04041	10 x 150mm FLAT BDMS	M	32.92	
MJ-A04042	12 x 16mm FLAT BDMS	M	8.05	
MJ-A04043	12 x 20mm FLAT BDMS	M	5.61	
MJ-A04044	12 x 25mm FLAT BDMS	M	7.05	
MJ-A04045	12 x 30mm FLAT BDMS	M	11.32	
MJ-A04046	12 x 40mm FLAT BDMS	M	10.80	
MJ-A04047	12 x 45mm FLAT BDMS	M	12.52	
MJ-A04048	12 x 50mm FLAT BDMS	M	11.23	
MJ-A04049	12 x 65mm FLAT BDMS	M	24.63	



MJ-A04050	12 x 75mm FLAT BDMS	M	21.60	
MJ-A04051	12 x 90mm FLAT BDMS	M	22.63	
MJ-A04052	12 x 100mm FLAT BDMS	M	24.19	
MJ-A04053	12 x 125mm FLAT BDMS	M	31.36	
MJ-A04054	12 x 150mm FLAT BDMS	M	41.47	
MJ-A04055	16 x 25mm FLAT BDMS	M	8.12	
MJ-A04056	16 x 50mm FLAT BDMS	M	14.95	
MJ-A04057	16 x 75mm FLAT BDMS	M	24.19	
MJ-A04058	16 x 100mm FLAT BDMS	M	28.68	
MJ-A04059	20 x 25mm FLAT BDMS	M	9.40	







MJ-A04060	20 x 40mm FLAT BDMS	M	13.15	
MJ-A04061	20 x 50mm FLAT BDMS	M	15.55	
MJ-A04062	20 x 75mm FLAT BDMS	M	32.31	
MJ-A04063	20 x 100mm FLAT BDMS	M	32.55	
MJ-A04064	20 x 150mm FLAT BDMS	M	32.83	
MJ-A04080	25 x 40mm FLAT BDMS	M	23.67	
MJ-A04082	25 x 50mm FLAT BDMS	M	24.36	
MJ-A04084	25 x 70mm FLAT BDMS	M	33.69	
MJ-A04086	25 x 80mm FLAT BDMS	M	35.39	
MJ-A04087	25 x 100mm FLAT BDMS	M	53.22	

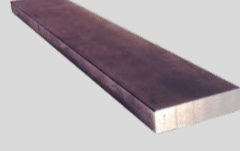

MJ-A04088	25 x 125mm FLAT BDMS	M	72.57	
MJ-A04089	25 x 150mm FLAT BDMS	M	74.30	
MJ-A04093	30 x 50mm FLAT BDMS	M	28.68	
MJ-A04100	40 x 80mm FLAT BDMS	M	58.62	
MJ-A04200	50 x 75mm FLAT BDMS	M	98.49	
MJ-A04204	50 x 125mm FLAT BDMS	M	135.82	

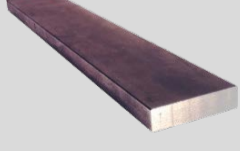

MJ-A05 **FLAT BDMS - IMPERIAL RUNNING DOWN**

MJ-A05002	1/16" x 5/8" FLAT BDMS	M	12.71	
MJ-A05003	1/8" x 1/4" FLAT BDMS	M	2.85	
MJ-A05007	1/8" x 5/8" FLAT BDMS	M	3.31	
MJ-A05022	3/16" x 3/8" FLAT BDMS	M	3.26	





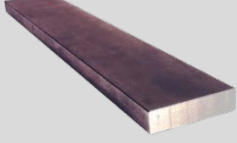

MJ-A05023	3/16" x 5/8" FLAT BDMS	M	3.61	
MJ-A05025	3/16" x 3/4" FLAT BDMS	M	3.57	
MJ-A05038	1/4" x 3/8" FLAT BDMS	M	3.42	
MJ-A05041	1/4" x 5/8" FLAT BDMS	M	2.24	
MJ-A05068	5/16" x 5/8" FLAT BDMS	M	4.96	
MJ-A05079	5/16" x 2 1/4" FLAT BDMS	M	5.79	
MJ-A05080	5/16" x 2 1/2" FLAT BDMS	M	10.71	
MJ-A05086	3/8" x 1/2" FLAT BDMS	M	3.75	
MJ-A05095	3/8" x 1 3/4" FLAT BDMS	M	9.35	
MJ-A05098	3/8" x 2 1/4" FLAT BDMS	M	14.69	
MJ-A05099	3/8" x 2 1/2" FLAT BDMS	M	22.48	

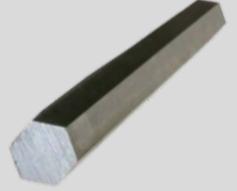

MJ-A05143	3/4" x 1 3/4" FLAT BDMS	M	12.09	
MJ-A05154	7/8" x 1" FLAT BDMS	M	9.47	
MJ-A05155	7/8" x 1 1/2" FLAT BDMS	M	26.00	
MJ-A05157	1" x 1 1/4" FLAT BDMS	M	16.12	
MJ-A05164	1" x 3" FLAT BDMS	M	40.78	

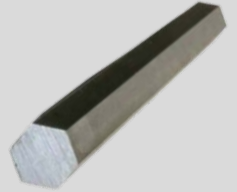

MJ-A06 BDMS HEXAGONAL - IMPERIAL

MJ-A06001	.170" HEXAGONAL BDMS AF	M	4.49	
MJ-A06002	.248" HEXAGONAL BDMS AF	M	12.63	
MJ-A06003	7/16" HEXAGONAL BDMS AF	M	11.52	
MJ-A06004	.5" HEXAGONAL BDMS AF	M	9.07	



MJ-A06009	.710" HEXAGONAL BDMS AF	M	12.68	
MJ-A06010	.920" HEXAGONAL BDMS AF	M	12.70	
MJ-A06012	1.25" HEXAGONAL BDMS AF	M	20.16	
MJ-A06013	1.48" HEXAGONAL BDMS AF	M	33.40	
MJ-A06015	1.48" HEXAGONAL BDMS AF	M	33.40	
MJ-A06016	2.05" HEXAGONAL BDMS AF	M	36.85	
MJ-A06018	65mm HEXAGONAL BDMS AF	M	63.93	

MJ-A07 **SQUARE BDMS - METRIC & IMPERIAL**

MJ-A07002	8.0mm SQUARE BDMS	M	3.62	
MJ-A07004	10.0mm SQUARE BDMS	M	3.45	
MJ-A07007	12.0mm SQUARE BDMS	M	5.35	





<u>Code</u>	<u>Product</u>	<u>Unit</u>	<u>Std. cost</u>	
MJ-A07008	5/8" SQUARE BDMS	M	8.12	
MJ-A07010	20mm SQUARE BDMS	M	9.67	
MJ-A07011	22mm SQUARE BDMS	M	12.96	
MJ-A07013	25mm SQUARE BDMS	M	13.82	
MJ-A07015	30mm SQUARE BDMS	M	19.08	
MJ-A07017	35mm SQUARE BDMS	M	34.21	
MJ-A07019	40mm SQUARE BDMS	M	32.83	
MJ-A07022	50mm SQUARE BDMS	M	41.90	
MJ-A07025	2 1/2" SQUARE BDMS	M	81.78	
MJ-A07027	3" SQUARE BDMS	M	127.68	



MJ-A07028	100mm SQUARE BDMS	M	200.43	
MJ-A07030	4 1/2" SQUARE BDMS	M	638.40	
MJ-A07031	5" SQUARE BDMS	M	220.32	
MJ-A07032	6" SQUARE BDMS	M	259.20	
<u>MJ-A08 MS ANGLE, CHANNEL TEE AND I SECTION</u>				
MJ-A08000	13 x 13 x 3mm MS ANGLE	M	2.07	
MJ-A08001	20 x 20 x 3mm MS ANGLE	M	2.16	
MJ-A08002	25 x 25 x 3mm MS ANGLE	M	2.16	
MJ-A08003	25 x 25 x 5mm MS ANGLE	M	3.28	
MJ-A08005	30 x 30 x 3mm MS ANGLE	M	2.90	

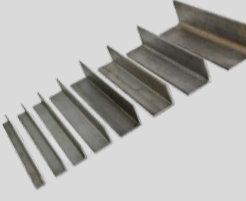

MJ-A08006	30 x 30 x 5mm MS ANGLE	M	4.45	
MJ-A08008	40 x 40 x 3mm MS ANGLE	M	3.37	
MJ-A08009	40 x 40 x 6mm MS ANGLE	M	5.79	
MJ-A08011	50 x 50 x 3mm MS ANGLE	M	3.63	
MJ-A08012	50 x 50 x 6mm MS ANGLE	M	5.65	
MJ-A08014	60 x 60 x 6mm MS ANGLE	M	8.47	
MJ-A08016	70 x 70 x 6mm MS ANGLE	M	11.80	
MJ-A08017	75 x 75 x 6mm MS ANGLE	M	10.39	
MJ-A08018	75 x 75 x 8mm MS ANGLE	M	9.98	
MJ-A08020	100 x 100 x 12mm MS ANGLE	M	24.53	



MJ-A08028	51 x 25 x 6mm MS CHANNEL	M	11.92	
MJ-A08029	76 x 38 x 6mm MS CHANNEL	M	14.11	
MJ-A08030	100 x 50 x 6mm MS CHANNEL	M	19.87	
MJ-A08031	150 x 75 x 10mm MS CHANNEL	M	27.65	
MJ-A08033	180 x 75 x 6mm MS CHANNEL	M	29.03	
MJ-A08038	76 x 130 x 8mm MS I SECTION	M	23.50	

MJ-A09 **MS TUBE - SQUARE & RECTANGULAR**

MJ-A09000	25 x 25 x 1.6mm STEEL TUBE	M	1.58	
MJ-A09001	25 x 25 x 3mm STEEL TUBE	M	3.82	
MJ-A09002	30 x 30 x 1.5mm STEEL TUBE	M	3.30	
MJ-A09004	30 x 30 x 3mm STEEL TUBE	M	5.04	







Code	Product	Unit	Std. cost	
MJ-A09005	40 x 40 x 1.5mm STEEL TUBE	M	4.80	
MJ-A09007	50 x 50 x 3mm STEEL TUBE	M	6.86	
MJ-A09008	60 x 60 x 3mm STEEL TUBE	M	9.93	
MJ-A09008A	60 x 60 x 5mm STEEL TUBE	M	14.77	
MJ-A09009	70 x 70 x 3mm STEEL TUBE	M	11.06	
MJ-A09010	75 x 75 x 3mm STEEL TUBE	M	12.09	
MJ-A09011	80 x 80 x 6.3mm STEEL TUBE	M	17.50	
MJ-A09012	100 x 100 x 5mm STEEL TUBE	M	21.17	
MJ-A09016	150 x 150 x 12mm STEEL TUBE	M	56.19	
MJ-A09025	50 x 25 x 1.6/2.0mm STEEL TUBE	M	5.18	



MJ-A09026	50 x 25 x 3mm STEEL TUBE	M	5.70	
MJ-A09028	60 x 40 x 4mm STEEL TUBE	M	9.15	
MJ-A09029	75 x 50 x 3mm STEEL TUBE	M	9.76	
MJ-A09034	100 x 60 x 3.6mm STEEL TUBE	M	19.14	

MJ-A10**MS TUBE - ROUND**

MJ-A10100	STEEL TUBE 3/4" O/D x 1/16" WALL	M	2.59	
MJ-A10102	STEEL TUBE 7/8" O/D x 1/16" WALL	M	2.67	
MJ-A10104	STEEL TUBE 1" OD x 1/16" WALL	M	2.24	
MJ-A10106	STEEL TUBE 1 1/8" OD x 1/16" WALL	M	3.71	
MJ-A10108	STEEL TUBE 1 1/4" OD x 1/16"WALL	M	4.32	



MJ-A10110	STEEL TUBE 1 3/8" OD x 1/16" WALL	M	4.32	
MJ-A10112	STEEL TUBE 1 1/2" OD x 1/16" WALL	M	3.80	
MJ-A10114	STEEL TUBE 1 3/4" OD x 1/16" WALL	M	5.60	
MJ-A10116	STEEL TUBE 2" OD x 1/16" WALL	M	4.23	
MJ-A10118	STEEL TUBE 2 1/2" OD x 1/16" WALL	M	8.91	
MJ-A10120	STEEL TUBE 70.0mm OD x 1.5mm WALL	M	8.01	

MJ-A11 EN STEELS - FLAT & ROUND

MJ-A11001	20mm dia. EN24	M	14.68	
MJ-A11003	25mm dia EN24	M	16.24	
MJ-A11005	30mm dia. EN24	M	24.88	



MJ-A11007	1 1/2" dia. EN24	M	39.13	
MJ-A11009	45mm dia. EN24	M	58.75	
MJ-A11011	2" dia. EN24	M	68.29	
MJ-A11013	2 1/4" dia. EN24	M	97.90	
MJ-A11017	3" dia. EN24	M	136.51	
MJ-A11023	110mm ROUND EN24 (RUNNING DOWN)	M	236.34	
MJ-A11030	2" dia. EN9	M	26.78	
MJ-A11031	2 1/8" dia. EN9	M	51.45	
MJ-A11033	2 1/2" dia. EN9	M	33.86	
MJ-A11040	55mm dia. EN3B	M	27.64	



MJ-A11041	55mm dia. EN6	M	38.01	
MJ-A11042	55mm dia. EN8	M	32.47	
MJ-A11051	100mm dia. EN31	M	121.40	
MJ-A11060	1/2" x 4" FLAT EN8	M	20.39	
MJ-A11061	2" x 4" FLAT EN24	M	97.90	

MJ-A12 BLACK MILD STEEL - FLAT & ROUND RUNNING DOWN

MJ-A12006	5/8" dia. ROUND BLACK MS	M	6.48	
MJ-A12007	1 1/8 dia. ROUND BLACK MS	M	8.56	
MJ-A12010	1 3/8" dia. ROUND BLACK	M	3.80	
MJ-A12015	40mm dia. ROUND BLACK MS	M	16.59	

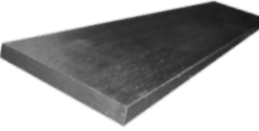
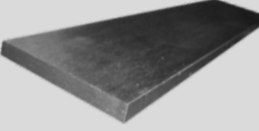
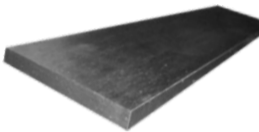
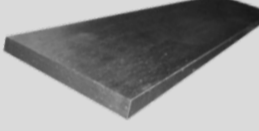
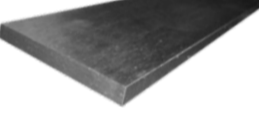
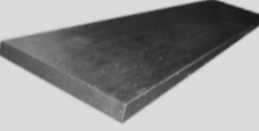
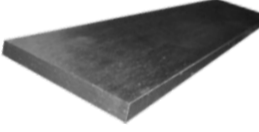

MJ-A12024	3/4" x 1 1/2" FLAT BLACK MS	M	7.70	
MJ-A12032	6 x 25mm FLAT BLACK MS	M	2.76	
MJ-A12033	6 x 50mm FLAT BLACK MS	M	4.37	
MJ-A12034	6 x 100mm FLAT BLACK BAR	M	6.91	
MJ-A12035	15 x 40mm FLAT BLACK MS	M	13.61	
MJ-A12036	16 x 20mm FLAT BLACK BAR	M	1.72	
MJ-A12037	20 x 20mm FLAT BLACK MS	M	4.40	

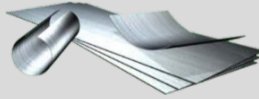
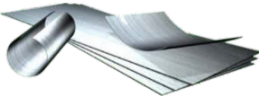

MJ-A13 STAINLESS STEEL SHEET

MJ-A13002	22swg STAINLESS STEEL SHEET [304 BRUSH FIN]	SQM	40.60	
MJ-A13003	20swg STAINLESS STEEL SHEET	SQM	39.74	



MJ-A13005	18swg STAINLESS STEEL SHEET [304]	SQM	45.79	
MJ-A13007	16swg STAINLESS STEEL SHEET	SQM	72.64	
MJ-A13009	14swg STAINLESS STEEL SHEET [304]	SQM	77.76	
MJ-A13011	3mm STAINLESS STEEL SHEET	SQM	115.60	

MJ-A14 STAINLESS STEEL ROUND - METRIC & IMPERIAL

MJ-A14000	5mm dia. ROUND STAINLESS STEEL	M	3.30	
MJ-A14001	6mm dia. ROUND STAINLESS STEEL [303]	M	2.24	
MJ-A14003	8mm dia. ROUND STAINLESS STEEL [303]	M	5.18	
MJ-A14004	10mm dia. ROUND STAINLESS STEEL	M	5.18	
MJ-A14005	12mm dia. ROUND STAINLESS STEEL	M	6.39	



MJ-A14007	16mm dia. ROUND STAINLESS STEEL	M	9.50	
MJ-A14008	20mm dia. ROUND STAINLESS STEEL	M	14.51	
MJ-A14010	7/8 dia. ROUND STAINLESS STEEL	M	22.46	
MJ-A14011	25mm dia. ROUND STAINLESS STEEL	M	28.80	
MJ-A14013	32mm dia. ROUND STAINLESS STEEL	M	43.10	
MJ-A14014	40mm dia. ROUND STAINLESS STEEL	M	61.17	
MJ-A14015	45mm dia. ROUND STAINLESS STEEL	M	95.86	
MJ-A14017	2" dia. ROUND STAINLESS STEEL	M	91.58	
MJ-A14019	2 1/4 dia. ROUND STAINLESS STEEL	M	119.02	
MJ-A14020	60mm dia. ROUND STAINLESS STEEL	M	127.09	

Code**Product****Unit****Std. cost**

MJ-A14021	2 1/2 dia. ROUND STAINLESS STEEL	M	127.87	
MJ-A14023	2 3/4 dia. ROUND STAINLESS STEEL	M	170.03	
MJ-A14025	3" dia. ROUND STAINLESS STEEL	M	216.00	
MJ-A14027	3 1/2" dia. ROUND STAINLESS STEEL	M	283.39	
MJ-A14029	4" dia. ROUND STAINLESS STEEL	M	397.44	
MJ-A14031	4 1/2" dia. ROUND STAINLESS BAR	M	547.77	

MJ-A15 **FLAT STAINLESS STEEL - METRIC & IMPERIAL**

MJ-A15003	3 x 20mm FLAT STAINLESS STEEL	M	4.49	
MJ-A15004	3 x 25mm FLAT STAINLESS STEEL	M	6.91	
MJ-A15012	5 x 25mm FLAT STAINLESS STEEL	M	11.23	



MJ-A15020	6 x 12mm FLAT STAINLESS STEEL	M	7.18	
MJ-A15022	6 x 20mm FLAT STAINLESS STEEL	M	6.04	
MJ-A15023	6 x 25mm FLAT STAINLESS STEEL	M	10.80	
MJ-A15025	6 x 40mm FLAT STAINLESS STEEL	M	14.75	
MJ-A15029	6 x 100mm FLAT STAINLESS STEEL	M	34.83	
MJ-A15050	20 x 25mm FLAT STAINLESS STEEL	M	16.41	
MJ-A15051	20 x 30mm FLAT STAINLESS STEEL	M	43.02	
MJ-A15052	20 x 40mm FLAT STAINLESS STEEL	M	42.45	
MJ-A15053	20 x 50mm FLAT STAINLESS STEEL	M	51.00	
MJ-A15060	3/4" SQUARE STAINLESS STEEL	M	21.08	







MJ-A15061	25 x 25mm SQUARE STAINLESS STEEL	M	38.01	
<u>MJ-A16 STAINLESS STEEL VARIOUS</u>				
MJ-A16035	1" STAINLESS HEXAGON 303 BAR A/F	M	40.26	
<u>MJ-A19 TOOL STEEL, GROUND STOCK SHIMS & KEY STEEL</u>				
MJ-A19008	Pack of GROUND FLAT STEEL 12 x 100mm	EA	79.75	
MJ-A19012	Pack of 3 GROUND FLAT STEEL 1 x 75mm	EA	22.63	
MJ-A19014	Pack of 3 GROUND FLAT STEEL 1.5 x 60mm	EA	8.29	
MJ-A19015	1.5mm x 75.0mm GROUND FLAT STEEL	EA	8.64	
MJ-A19017	Pack of GROUND FLAT STEEL 2 x 75mm	EA	21.04	
MJ-A19022	Pack of 3 GROUND FLAT STEEL 25 x 5mm	EA	14.53	
MJ-A19025	Pack of 2 GROUND FLAT STEEL 6 x 20mm	EA	11.80	



MJ-A19030	Pack of 2 GROUND FLAT STEEL 10 x 25mm	EA	20.50	
MJ-A19033	Pack of GROUND FLAT STEEL 75 x 15mm	EA	52.58	
MJ-A19050	60.0mm dia. GROUND PRECISION BAR	M	207.36	
MJ-A19060	Box of ASSORTED KEY STEEL	EA	6.46	

<u>Code</u>	<u>Product</u>	<u>Unit</u>	<u>Std. cost</u>
MJ-A20	SILVER STEEL ROUND - METRIC & IMPERIAL		

MJ-A20002	0.015" dia. SILVER STEEL	EA	0.86	
MJ-A20003	0.020" dia. SILVER STEEL	EA	0.86	
MJ-A20004	0.025" dia. SILVER STEEL	EA	0.86	
MJ-A20005	0.030" dia. SILVER STEEL	EA	0.86	
MJ-A20006	0.035" dia. SILVER STEEL	EA	0.86	



MJ-A20008	0.045" dia. SILVER STEEL	EA	0.86	
MJ-A20009	0.050" dia. SILVER STEEL	EA	0.86	
MJ-A20011	0.060" dia. SILVER STEEL	EA	0.86	
MJ-A20012	0.065" dia. SILVER STEEL	EA	0.86	
MJ-A20013	0.070" dia. SILVER STEEL	EA	0.86	
MJ-A20014	0.075" dia. SILVER STEEL	EA	0.86	
MJ-A20015	0.080" dia. SILVER STEEL	EA	0.86	
MJ-A20016	0.085" dia. SILVER STEEL	EA	0.86	
MJ-A20017	0.090" dia. SILVER STEEL	EA	0.86	
MJ-A20018	0.095" dia. SILVER STEEL	EA	0.86	











MJ-A20019	0.100" dia. SILVER STEEL	EA	0.86	
MJ-A20020	0.105" dia. SILVER STEEL	EA	0.86	
MJ-A20021	0.110" dia. SILVER STEEL	EA	0.86	
MJ-A20022	0.115" dia. SILVER STEEL	EA	0.86	
MJ-A20023	0.120" dia. SILVER STEEL	EA	0.86	
MJ-A20024	0.135" dia. SILVER STEEL	EA	0.86	
MJ-A20025	0.140" dia. SILVER STEEL	EA	0.86	
MJ-A20026	0.145" dia. SILVER STEEL	EA	0.86	
MJ-A20027	0.155" dia. SILVER STEEL	EA	0.86	
MJ-A20028	0.175" dia. SILVER STEEL	EA	0.86	





MJ-A20029	0.185" dia. SILVER STEEL	EA	0.86	
MJ-A20030	0.195" dia. SILVER STEEL	EA	0.86	
MJ-A20031	0.205" dia. SILVER STEEL	EA	0.86	
MJ-A20032	0.215" dia. SILVER STEEL	EA	0.86	
MJ-A20033	0.225" dia. SILVER STEEL	EA	0.86	
MJ-A20034	0.235" dia. SILVER STEEL	EA	0.86	
MJ-A20035	0.245" dia. SILVER STEEL	EA	0.86	
MJ-A20036	0.265" dia. SILVER STEEL	EA	0.86	
MJ-A20037	0.275" dia. SILVER STEEL	EA	0.86	
MJ-A20038	0.285" dia. SILVER STEEL	EA	0.86	





MJ-A20039	0.295" dia. SILVER STEEL	EA	0.86	
MJ-A20040	0.305" dia. SILVER STEEL	EA	0.86	
MJ-A20041	0.325" dia. SILVER STEEL	EA	0.86	
MJ-A20042	0.335" dia. SILVER STEEL	EA	0.86	
MJ-A20043	0.345" dia. SILVER STEEL	EA	0.86	
MJ-A20044	0.355" dia. SILVER STEEL	EA	0.86	
MJ-A20045	0.365" dia. SILVER STEEL	EA	0.86	
MJ-A20051	1/8" SILVER STEEL ROD	EA	0.86	
<u>Code</u>	<u>Product</u>	<u>Unit</u>	<u>Std. cost</u>	
MJ-A20052	5/32" SILVER STEEL ROD	EA	1.34	



MJ-A20053	3/16" SILVER STEEL ROD	EA	1.72	
MJ-A20056	1/4" SILVER STEEL ROD	EA	1.95	
MJ-A20059	5/16" SILVER STEEL ROD	EA	3.59	
MJ-A20063	13/32" SILVER STEEL ROD	EA	5.32	
MJ-A20064	7/16" SILVER STEEL ROD	EA	5.30	
MJ-A20065	15/32" SILVER STEEL ROD	EA	4.85	
MJ-A20066	1/2" SILVER STEEL ROD	EA	5.54	
MJ-A20067	9/16" SILVER STEEL ROD	EA	7.51	
MJ-A20069	11/16" SILVER STEEL ROD	EA	8.62	
MJ-A20070	3/4" SILVER STEEL ROD	EA	11.43	



MJ-A20071	7/8" SILVER STEEL ROD	EA	15.88	
MJ-A20072	1" SILVER STEEL ROD	EA	13.20	
MJ-A20090	5mm SILVER STEEL ROD	EA	1.60	
MJ-A20091	6mm SILVER STEEL ROD	EA	3.37	
MJ-A20092	7mm SILVER STEEL ROD	EA	2.83	
MJ-A20093	8mm SILVER STEEL ROD	EA	4.03	
MJ-A20094	9mm SILVER STEEL ROD	EA	3.61	
MJ-A20095	10mm SILVER STEEL ROD	EA	5.86	
MJ-A20096	11mm SILVER STEEL ROD	EA	4.56	
MJ-A20097	12mm SILVER STEEL ROD	EA	7.86	



MJ-A20098	16mm SILVER STEEL ROD	EA	8.88	



L2 STORES CATALOGUE

NON-FERROUS MATERIALS - B



Code **Product** **Unit** **Std. cost**

B **NON-FERROUS MATERIALS**

MJ-B01 **ALUMINIUM SHEET AND PLATE**

MJ-B01001	22g 0.7mm ALUMINIUM SHEET [1050]	SQM	18.48	
MJ-B01002	20g 0.9mm ALUMINIUM SHEET	SQM	19.50	
MJ-B01003	18g 1.2mm ALUMINIUM SHEET [1050]	SQM	20.41	
MJ-B01004	16g 1.5mm ALUMINIUM SHEET [1050]	SQM	26.43	
MJ-B01005	14g 2.0mm ALUMINIUM SHEET [1050]	SQM	32.00	
MJ-B01007	10g 3.0mm ALUMINIUM PLATE [1050]	SQM	41.26	
MJ-B01011	1200 x 1200 x 6mm ALUMINIUM PLATE [6082]	SQM	180.00	

MJ-B02 **ROUND ALUMINIUM IMPERIAL**

MJ-B02001	1/8" dia. ROUND ALUMINIUM	M	2.40	
MJ-B02002	5.0mm dia. ROUND ALUMINIUM	M	3.78	
MJ-B02004	1/4" dia. ROUND ALUMINIUM	M	2.41	













MJ-B02006	8.0mm dia. ROUND ALUMINIUM	M	3.00	
MJ-B02008	3/8" dia. ROUND ALUMINIUM	M	2.48	
MJ-B02010	12.0mm dia. ROUND ALUMINIUM	M	4.75	
MJ-B02012	16.0mm dia. ROUND ALUMINIUM	M	7.37	
MJ-B02014	3/4" dia. ROUND ALUMINIUM	M	5.18	
MJ-B02016	7/8" dia. ROUND ALUMINIUM	M	9.07	
MJ-B02018	1" dia. ROUND ALUMINIUM	M	9.13	
MJ-B02020	1 1/8" dia. ROUND ALUMINIUM	M	12.52	
MJ-B02022	1 1/4" dia. ROUND ALUMINIUM	M	15.03	
MJ-B02024	1 1/2" dia. ROUND ALUMINIUM [6082]	M	24.19	







MJ-B02026	1 3/4" dia. ROUND ALUMINIUM	M	31.79	
MJ-B02028	2" dia. ROUND ALUMINIUM	M	36.37	
MJ-B02030	2 1/2" dia. ROUND ALUMINIUM	M	56.00	
MJ-B02032	2 3/4" dia. ROUND ALUMINIUM	M	60.48	
MJ-B02034	3" dia. ROUND ALUMINIUM [6082]	M	75.68	
MJ-B02036	3 1/2" dia. ROUND ALUMINIUM	M	105.40	
MJ-B02038	4" dia. ROUND ALUMINIUM	M	143.42	
MJ-B02042	5" dia. ROUND ALUMINIUM	M	203.90	
MJ-B02044	5 1/2" dia. ROUND ALUMINIUM	M	239.39	
MJ-B02046	6" dia. ROUND ALUMINIUM	M	324.65	









[MJ-B03](#) [ALUMINIUM FLAT](#)









MJ-B03002	1/8" x 1/2" ALUMINIUM FLAT	M	3.00	
MJ-B03004	1/8" x 5/8" ALUMINIUM FLAT	M	2.61	
MJ-B03006	3 x 20mm ALUMINIUM FLAT	M	2.92	
MJ-B03008	1/8" x 1" ALUMINIUM FLAT	M	2.52	
MJ-B03010	1/8" x 1 1/2 ALUMINIUM FLAT	M	3.14	
MJ-B03012	3 x 50mm ALUMINIUM FLAT	M	5.00	
MJ-B03018	3/16" x 3/4" ALUMINIUM FLAT	M	2.33	
MJ-B03020	3/16" x 1" ALUMINIUM FLAT	M	4.87	
MJ-B03022	5 x 40mm ALUMINIUM FLAT	M	6.74	
MJ-B03024	3/16" x 2" ALUMINIUM FLAT	M	5.18	



MJ-B03030	1/4" x 1/2" ALUMINIUM FLAT	M	3.04	
MJ-B03032	1/4" x 3/4" ALUMINIUM FLAT	M	2.59	
MJ-B03034	1/4" x 1" ALUMINIUM FLAT	M	3.54	
MJ-B03036	1/4" x 1 1/4" ALUMINIUM FLAT	M	5.14	

<u>Code</u>	<u>Product</u>	<u>Unit</u>	<u>Std. cost</u>	
MJ-B03038	1/4" x 1 1/2" ALUMINIUM FLAT	M	4.96	
MJ-B03040	6 x 50mm ALUMINIUM FLAT	M	7.17	
MJ-B03042	1/4" x 2 1/2" ALUMINIUM FLAT	M	8.98	
MJ-B03044	1/4" x 3" ALUMINIUM FLAT	M	12.44	
MJ-B03046	1/4" x 4" ALUMINIUM FLAT	M	11.75	
MJ-B03048	1/4" x 5" ALUMINIUM FLAT	M	14.77	



MJ-B03050	5/16" x 1" ALUMINIUM FLAT	M	4.49	
MJ-B03052	5/16" x 1 1/4" ALUMINIUM FLAT	M	5.96	
MJ-B03054	8mm x 40mm ALUMINIUM FLAT	M	8.55	
MJ-B03056	5/16" x 2" ALUMINIUM FLAT	M	8.20	
MJ-B03060	3/8" x 1/2" ALUMINIUM FLAT	M	3.66	
MJ-B03062	3/8" x 5/8" ALUMINIUM FLAT	M	3.59	
MJ-B03064	3/8" x 3/4" ALUMINIUM FLAT	M	4.59	
MJ-B03066	3/8" x 1" ALUMINIUM FLAT	M	4.49	
MJ-B03067	3/8" x 1 1/4" ALUMINIUM FLAT	M	5.25	
MJ-B03068	10 x 40mm ALUMINIUM FLAT	M	9.50	







MJ-B03070	10mm x 50mm ALUMINIUM FLAT [HE30TF]	M	12.96	
MJ-B03071	3/8" x 2 1/2" ALUMINIUM FLAT	M	12.52	
MJ-B03072	3/8" x 3" ALUMINIUM FLAT	M	13.39	
MJ-B03074	3/8" x 4" ALUMINIUM FLAT	M	14.68	
MJ-B03076	3/8" x 6" ALUMINIUM FLAT [6063]	M	38.30	
MJ-B03080	1/2" x 3/4" ALUMINIUM FLAT	M	6.25	
MJ-B03082	1/2" x 1" ALUMINIUM FLAT	M	7.01	
MJ-B03084	12 x 40mm ALUMINIUM FLAT	M	11.23	
MJ-B03086	1/2" x 2" ALUMINIUM FLAT	M	13.65	
MJ-B03088	1/2" x 2 1/2" ALUMINIUM FLAT	M	14.86	









MJ-B03090	1/2" x 3" ALUMINIUM FLAT	M	17.97	
MJ-B03092	1/2" x 4" ALUMINIUM FLAT	M	20.44	
MJ-B03094	1/2" x 6" ALUMINIUM FLAT	M	36.28	
MJ-B03095	1/2" x 8" ALUMINIUM FLAT	M	56.16	
MJ-B03100	5/8" x 1" ALUMINIUM FLAT	M	7.00	
MJ-B03102	5/8" x 1 1/2" ALUMINIUM FLAT [6082T6]	M	11.23	
MJ-B03104	5/8" x 2 1/2" ALUMINIUM FLAT	M	23.76	
MJ-B03110	3/4" x 1" ALUMINIUM FLAT	M	7.22	
MJ-B03112	3/4" x 2 1/2" ALUMINIUM FLAT	M	20.73	
MJ-B03114	3/4" x 3" ALUMINIUM FLAT	M	20.73	











MJ-B03120	1" x 1 1/2" ALUMINIUM FLAT	M	15.98	
MJ-B03122	1" x 1 3/4" ALUMINIUM FLAT	M	20.10	
MJ-B03124	1" x 2" ALUMINIUM FLAT	M	20.73	
MJ-B03126	1" x 3" ALUMINIUM FLAT	M	28.51	

MJ-B04 SQUARE ALUMINIUM

MJ-B04002	1/4" SQUARE ALUMINIUM	M	3.45	
MJ-B04004	3/8" SQUARE ALUMINIUM	M	4.06	
MJ-B04006	1/2" SQUARE ALUMINIUM	M	5.02	
MJ-B04008	5/8" SQUARE ALUMINIUM	M	6.22	
MJ-B04010	3/4" SQUARE ALUMINIUM	M	9.34	
MJ-B04012	7/8" SQUARE ALUMINIUM	M	10.36	



MJ-B04014	1" SQUARE ALUMINIUM	M	11.23	
Code	Product	Unit	Std. cost	
MJ-B04016	1 1/4" SQUARE ALUMINIUM	M	19.00	
MJ-B04018	1 1/2" SQUARE ALUMINIUM	M	27.64	
MJ-B04019	1 3/4" SQUARE ALUMINIUM	M	34.21	
MJ-B04022	2" SQUARE ALUMINIUM	M	40.00	
MJ-B04024	2 1/2" SQUARE ALUMINIUM	M	64.80	
MJ-B04026	3" SQUARE ALUMINIUM	M	98.49	
MJ-B04028	3 1/2" SQUARE ALUMINIUM	M	151.20	
MJ-B04030	4" SQUARE ALUMINIUM [6082]	M	186.62	



MJ-B05 ALUMINIUM ANGLE / CHANNEL / T-SECTION - METRIC & IMPERIAL

MJ-B05002	1/2" x 1/2" x 1/16" ALUMINIUM ANGLE	M	2.01	
-----------	-------------------------------------	---	------	---



MJ-B05003	1" x 1" x 1/16" ALUMINIUM ANGLE	M	3.11	
MJ-B05004	1/2" x 1/2" x 1/8" ALUMINIUM ANGLE	M	1.55	
MJ-B05016	25 x 25 x 3mm ALUMINIUM ANGLE	M	4.93	
MJ-B05022	1 1/2" x 1 1/2" x 1/8" ALUMINIUM ANGLE	M	5.01	
MJ-B05024	2" x 2" x 1/8" ALUMINIUM ANGLE	M	7.25	
MJ-B05030	1" x 1" x 3/16" ALUMINIUM ANGLE	M	4.83	
MJ-B05032	1 1/2" x 1 1/2" x 3/16" ALUMINIUM ANGLE	M	6.39	
MJ-B05034	2" x 2" x 3/16" ALUMINIUM ANGLE	M	11.40	
MJ-B05040	1" x 1" x 1/4" ALUMINIUM ANGLE	M	6.39	
MJ-B05042	1 1/4" x 1 1/4" x 1/4" ALUMINIUM ANGLE	M	6.91	



MJ-B05044	1 1/2" x 1 1/2" x 1/4" ALUMINIUM ANGLE	M	5.70	
MJ-B05046	2" x 2" x 1/4" ALUMINIUM ANGLE	M	13.13	







MJ-B08 ROUND BRASS - IMPERIAL

MJ-B08006	6mm dia. ROUND BRASS	M	4.18	
MJ-B08010	10mm dia. ROUND BRASS [CZ121]	M	7.91	
MJ-B08016	3/4" dia. ROUND BRASS	M	26.10	
MJ-B08020	1" dia. ROUND BRASS [CZ121]	M	43.77	
MJ-B08022	1 1/4" dia. ROUND BRASS [CZ121]	M	67.96	
MJ-B08026	1 1/2" dia. ROUND BRASS [CZ121]	M	93.88	
MJ-B08036	3" dia. ROUND BRASS (RUNNING DOWN)	M	392.25	

MJ-B09 FLAT BRASS - IMPERIAL

MJ-B09002	1/8" x 1/2" FLAT BRASS	M	7.82	
-----------	------------------------	---	------	---



MJ-B09004	1/8" x 3/4" FLAT BRASS	M	9.84	
MJ-B09006	1/8" x 1" FLAT BRASS	M	10.36	
MJ-B09008	1/8" x 1 1/2" FLAT BRASS	M	15.81	
MJ-B09010	1/8" x 2" FLAT BRASS	M	13.15	
MJ-B09014	1/4" x 2" FLAT BRASS	M	13.15	
MJ-B09016	1/4" x 1 1/4" FLAT BRASS	M	17.28	
MJ-B09018	1/4" x 1 1/2" FLAT BRASS	M	6.32	
MJ-B09020	1/4" x 2" FLAT BRASS	M	23.67	
MJ-B09026	3/8" x 1/2" FLAT BRASS	M	9.86	
Code	Product	Unit	Std. cost	
MJ-B09028	3/8" x 3/4" FLAT BRASS	M	13.47	









MJ-B09030	3/8" x 1" FLAT BRASS	M	25.92	
MJ-B09034	3/8" x 2" FLAT BRASS	M	52.53	
MJ-B09036	1/2" x 1" FLAT BRASS	M	16.48	
MJ-B09038	1/2" x 1 1/2" FLAT BRASS	M	39.08	
MJ-B09040	1/2" x 2" FLAT BRASS	M	24.48	
MJ-B09042	1/2" x 2 1/2" FLAT BRASS	M	71.14	
MJ-B09044	3/4" x 1" FLAT BRASS	M	25.26	
MJ-B09046	3/4" x 1 1/2" FLAT BRASS	M	82.33	
MJ-B09048	3/4" x 2" FLAT BRASS	M	112.32	





MJ-B10 BRASS HEXAGONAL - METRIC & IMPERIAL

MJ-B10004	1/4" HEXAGONAL BRASS AF	M	5.98	
-----------	-------------------------	---	------	---



MJ-B10008	3/8" HEXAGONAL BRASS AF	M	9.79	
MJ-B10010	7/16" HEXAGONAL BRASS AF	M	4.09	
MJ-B10012	1/2" HEXAGONAL BRASS AF	M	11.71	
MJ-B10014	16mm HEXAGONAL BRASS AF	M	21.09	
MJ-B10016	3/4" HEXAGONAL BRASS AF	M	24.88	
MJ-B10022	22mm HEXAGONAL BRASS AF	M	35.25	



MJ-B11 BRASS SQUARE

MJ-B11004	1/4" SQUARE BRASS	M	8.29	
MJ-B11008	5/16" SQUARE BRASS	M	6.91	
MJ-B11010	3/8" SQUARE BRASS	M	12.32	
MJ-B11014	5/8" SQUARE BRASS	M	15.89	

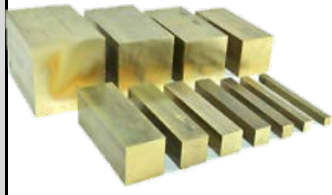
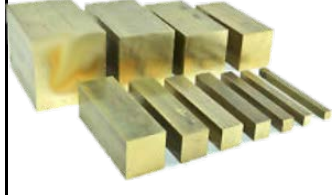
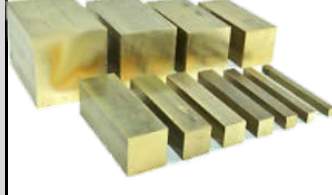
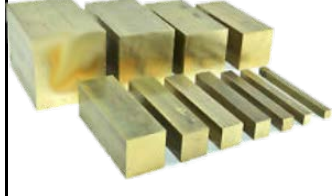



MJ-B11016	3/4" SQUARE BRASS	M	13.65	
MJ-B11018	7/8" SQUARE BRASS	M	15.79	
MJ-B11020	1" SQUARE BRASS	M	62.20	
MJ-B11022	2" SQUARE BRASS (RUNNING DOWN)	M	262.81	











MJ-B14 COPPER ROUND

MJ-B14004	1/4" dia. COPPER ROUND	M	12.96	
MJ-B14008	3/8" dia. COPPER ROUND	M	12.19	









MJ-B15 COPPER SQUARE / FLAT

MJ-B15002	10mm COPPER SQUARE [HC101]	M	15.55	
MJ-B15010	1/4" x 1" COPPER FLAT	M	5.10	



<u>Code</u>	<u>Product</u>	<u>Unit</u>	<u>Std. cost</u>	
C <u>ML-C01</u>	SYNTHETICS BLACK NYLATRON - METRIC & IMPERIAL			
ML-C01002	10mm dia. BLACK NYLATRON ROD	M	5.14	
ML-C01004	12mm dia. BLACK NYLOTRON ROD	M	4.37	
ML-C01006	16mm dia. BLACK NYLATRON ROD	M	13.73	
ML-C01008	20mm dia. BLACK NYLATRON ROD	M	11.49	
ML-C01010	25mm dia. BLACK NYLATRON ROD	M	12.44	
ML-C01014	45mm dia. BLACK NYLATRON ROD (RUNNING DOWN)	M	39.79	
ML-C01016	50mm dia. BLACK NYLATRON ROD	M	61.89	
ML-C01018	60mm dia. BLACK NYLATRON ROD	M	80.74	
ML-C01020	70mm dia. NYLATRON ROD	M	78.17	
ML-C02	NYLON - METRIC & IMPERIAL			
ML-C02002	6mm dia. WHITE NYLON ROD	M	3.45	



ML-C02006	10mm dia. WHITE NYLON ROD	M	2.86	
ML-C02008	12mm dia. WHITE NYLON ROD	M	2.86	
ML-C02010	16mm dia. WHITE NYLON ROD	M	5.78	
ML-C02012	20mm dia. WHITE NYLON ROD	M	9.93	
ML-C02014	25mm dia. WHITE NYLON ROD	M	12.44	
ML-C02016	30mm dia. WHITE NYLON ROD	M	16.12	
ML-C02018	40mm dia. WHITE NYLON ROD	M	26.87	
ML-C02019	45mm dia. WHITE NYLON ROD	M	51.30	
ML-C02020	50mm dia. WHITE NYLON ROD	M	34.56	
ML-C02021	60MM dia. WHITE NYLON ROD	M	88.09	
ML-C02022	65mm dia. WHITE NYLON ROD	M	108.00	



ML-C02024	70mm dia. WHITE NYLON ROD	M	86032	
ML-C02025	75mm dia. WHITE NYLON ROD	M	72.57	
ML-C02026	80mm dia. WHITE NYLON ROD	M	132.62	
ML-C02030	100mm dia. WHITE NYLON ROD	M	136.51	



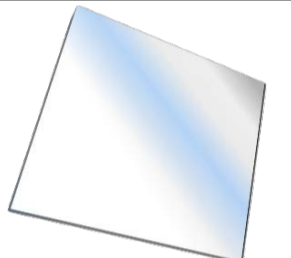
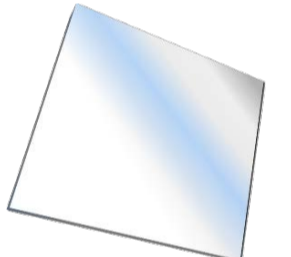
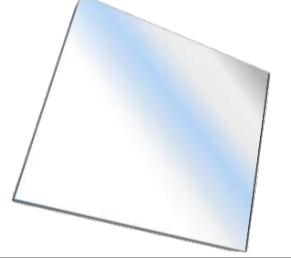
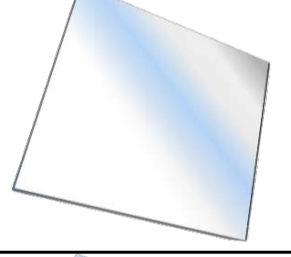
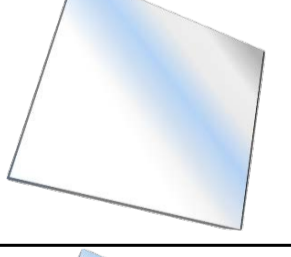
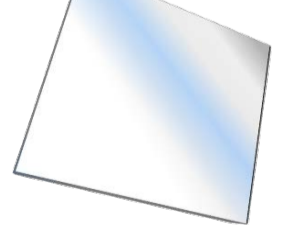

ML-C03 PERSPEX SHEET

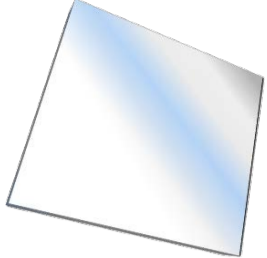
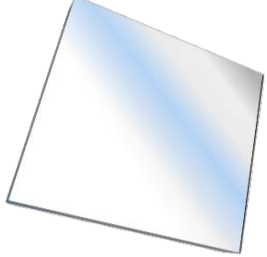
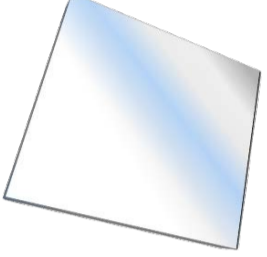
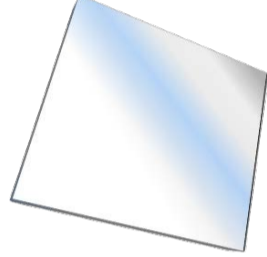
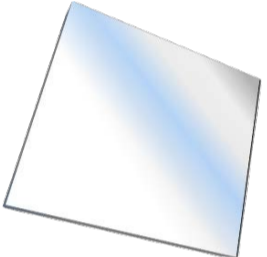
ML-C03002	Sheet of 2.0mm CLEAR ACRYGLAS	SQM	16.84	
ML-C03004	Sheet of 3.0mm CLEAR ACRYLIC	SQM	16.32	
ML-C03006	Sheet of 4.0mm CLEAR ACRYLIC	SQM	21.77	
ML-C03008	Sheet of 5.0mm CLEAR ACRYLIC	SQM	27.21	
ML-C03010	Sheet of 6.0mm CLEAR ACRYLIC	SQM	45.11	
ML-C03012	Sheet of 8.0mm CLEAR ACRYLIC	SQM	64.45	



ML-C03014	(2m x 1m) Sheet of 10.0mm CLEAR EXTRUDED ACRYLIC	SQM	80.17	
ML-C03016	(2m x 1m) Sheet of 12.0mm CLEAR EXTRUDED ACRYLIC	SQM	96.16	
ML-C03020	Sheet of 15.0mm CLEAR ACRYLIC	SQM	126.14	
ML-C03030	(1.0mm POLYCARBONATE BLANK (110 x 270mm))	EA	1.17	
ML-C03033	Sheet of 6.0mm MAKROLON POLYCARBONATE	SQM	59.96	

ML-C04 PERSPEX ROD & TUBE





ML-C04000	6mm dia. ACRYLIC ROD	M	7.08	
ML-C04001	10.0mm dia. ACRYLIC ROD	M	7.02	
ML-C04002	15.0mm dia. PERSPEX ROD	M	12.09	
ML-C04003	20.0mm dia. ACRYLIC ROD	M	17.28	

<u>Code</u>	<u>Product</u>	<u>Unit</u>	<u>Std. cost</u>
ML-C05	PTFE ROD		



ML-C05002	15.0mm dia. PTFE ROD	M	18.14	
-----------	----------------------	---	-------	---



ML-C06 **ENGRAVING SHEET RUNNING DOWN**

ML-C06004	1.5mm WHITE / BLACK / WHITE ENGRAVING SHEET (RUN DOWN)	SQM	41.33	
ML-C06006	1.5mm GREEN / WHITE ENGRAVING SHEET (RUN DOWN)	SQM	41.43	
ML-C06008	1.5mm YELLOW / BLACK / YELLOW ENGRAVING SHEET (RUN DOWN)	SQM	43.58	
ML-C06010	1.5mm BLUE / WHITE / BLUE ENGRAVING SHEET (RUN DOWN)	SQM	50.92	
ML-C06012	3 PLY WHITE / RED / WHITE ENGRAVING SHEET (RUN DOWN)	SQM	49.54	
ML-C06013	3 PLY RED / WHITE / RED ENGRAVING SHEET (RUN DOWN)	SQM	41.45	

ML-C07 **RUBBER SHEET**

ML-C07002	(1.2m roll of) 1.5mm NEOPRENE RUBBER SHEET	SQM	33.62	
ML-C07005	(1.2m roll of) 3.0mm NEOPRENE RUBBER SHEET	SQM	56.59	



ML-C07012	(1.2m roll of) 6.0mm NEOPRENE RUBBER SHEET - 1m WIDE	SQM	135.88	
-----------	--	-----	--------	---









<u>Code</u>	<u>Product</u>	<u>Unit</u>	<u>Std. cost</u>
D	FASTENERS		
<u>MH-D01</u>	<u>STAINLESS HEX HEAD SET SCREWS</u>		

MH-D01015	4 x 25 STAINLESS HEX HEAD SET SCREW	EA	0.11	
MH-D01019	5 x 25 STAINLESS HEX HEAD SET SCREW	EA	0.19	
MH-D01025	5 x 50 STAINLESS HEX HEAD SET SCREW	EA	0.22	
MH-D01030	6 x 25 STAINLESS HEX HEAD SET SCREW	EA	0.12	
MH-D01035	6 x 30 STAINLESS HEX HEAD SET SCREW	EA	0.12	
MH-D01040	6 x 40 STAINLESS HEX HEAD SET SCREW	EA	0.19	
MH-D01045	6 x 50 STAINLESS HEX HEAD SET SCREW	EA	0.14	
MH-D01050	8 x 25 STAINLESS HEX HEAD SET SCREW	EA	0.10	
MH-D01055	8 x 30 STAINLESS HEX HEAD SET SCREW	EA	0.40	
MH-D01060	8 x 50 STAINLESS HEX HEAD SET SCREW	EA	0.36	













MH-D01065	10 x 16 STAINLESS HEX HEAD SET SCREW	EA	0.36	
MH-D01070	10 x 25 STAINLESS HEX HEAD SET SCREW	EA	0.19	
MH-D01075	10 x 30 STAINLESS HEX HEAD SET SCREW	EA	0.34	
MH-D01077	10 x 50 STAINLESS HEX HEAD SET SCREW	EA	0.48	









MH-D02 HEX HEAD STEEL SET SCREWS - METRIC ZINC PLATED

MH-D02013	3 x 25 HEX HEAD STEEL	EA	0.09	
MH-D02016	4 x 12 HEX HEAD STEEL	EA	0.04	
MH-D02020	4 x 16 HEX HEAD STEEL	EA	0.05	
MH-D02024	4 x 20 HEX HEAD STEEL	EA	0.10	
MH-D02027	4 x 25 HEX HEAD STEEL	EA	0.06	
MH-D02030	4 x 50 HEX HEAD STEEL	EA	0.06	





MH-D02033	5 x 12 HEX HEAD STEEL	EA	0.04	
MH-D02036	5 x 16 HEX HEAD STEEL	EA	0.13	
MH-D02040	5 x 20 HEX HEAD STEEL	EA	0.10	
MH-D02043	5 x 25 HEX HEAD STEEL	EA	0.09	
MH-D02046	5 x 35 HEX HEAD STEEL	EA	0.12	
MH-D02050	5 x 50 HEX HEAD STEEL	EA	0.12	
MH-D02053	6 x 12 HEX HEAD STEEL	EA	0.06	
MH-D02056	6 x 16 HEX HEAD STEEL	EA	0.09	
MH-D02060	6 x 20 HEX HEAD STEEL	EA	0.11	
MH-D02063	6 x 25 HEX HEAD STEEL	EA	0.06	
MH-D02066	6 x 30 HEX HEAD STEEL	EA	0.08	













MH-D02070	6 x 35 HEX HEAD STEEL	EA	0.08	
MH-D02073	6 x 40 HEX HEAD STEEL	EA	0.10	
MH-D02075	6 x 45 HEX HEAD STEEL	EA	0.13	
MH-D02078	6 x 50 HEX HEAD STEEL	EA	0.06	
MH-D02080	8 x 16 HEX HEAD STEEL	EA	0.10	
MH-D02083	8 x 20 HEX HEAD STEEL	EA	0.07	
MH-D02086	8 x 25 HEX HEAD STEEL	EA	0.20	
MH-D02090	8 x 30 HEX HEAD STEEL	EA	0.09	
MH-D02093	8 x 35 HEX HEAD STEEL	EA	0.08	











Code**Product****Unit****Std. cost**

MH-D02096	8 x 40 HEX HEAD STEEL	EA	0.07	
MH-D02099	8 x 45 HEX HEAD STEEL	EA	0.09	













MH-D02102	8 x 50 HEX HEAD STEEL	EA	0.17	
MH-D02103	8 x 55 HEX HEAD STEEL	EA	0.24	
MH-D02105	8 x 60 HEX HEAD STEEL	EA	0.16	
MH-D02108	8 x 70 HEX HEAD STEEL	EA	0.20	
MH-D02111	10 x 16 HEX HEAD STEEL	EA	0.15	
MH-D02114	10 x 20 HEX HEAD STEEL	EA	0.26	
MH-D02117	10 x 25 HEX HEAD STEEL	EA	0.17	
MH-D02120	10 x 30 HEX HEAD STEEL	EA	0.12	
MH-D02123	10 x 35 HEX HEAD STEEL	EA	0.25	
MH-D02126	10 x 40 HEX HEAD STEEL	EA	0.27	
MH-D02129	10 x 45 HEX HEAD STEEL	EA	0.32	



MH-D02132	10 x 50 HEX HEAD STEEL	EA	0.20	
MH-D02135	10 x 55 HEX HEAD STEEL	EA	0.31	
MH-D02138	10 x 60 HEX HEAD STEEL	EA	0.53	
MH-D02141	12 x 25 HEX HEAD STEEL	EA	0.31	
MH-D02144	12 x 30 HEX HEAD STEEL	EA	0.32	
MH-D02147	12 x 35 HEX HEAD STEEL	EA	0.36	
MH-D02150	12 x 40 HEX HEAD STEEL	EA	0.37	
MH-D02153	12 x 45 HEX HEAD STEEL	EA	0.27	
MH-D02154	12 x 50 HEX HEAD STEEL	EA	0.36	
MH-D02155	12 x 60 HEX HEAD STEEL	EA	0.44	
MH-D02156	12 x 80 HEX HEAD STEEL	EA	0.28	





MH-D02158	16 x 25 HEX HEAD STEEL	EA	0.58	
MH-D02159	16 x 40 HEX HEAD STEEL	EA	1.02	
MH-D02162	16 x 45 HEX HEAD STEEL	EA	0.77	
MH-D02165	16 x 50 HEX HEAD STEEL	EA	1.26	
MH-D02168	16 x 55 HEX HEAD STEEL	EA	0.99	
MH-D02171	16 x 60 HEX HEAD STEEL	EA	0.68	
MH-D02174	16 x 70 HEX HEAD STEEL	EA	2.50	
MH-D02175	20 x 50 HEX HEAD STEEL	EA	1.49	
MH-D02177	20 x 60 HEX HEAD STEEL	EA	1.80	
MH-D02180	20 x 70 HEX HEAD STEEL	EA	2.05	
MH-D02183	20 x 80 HEX HEAD STEEL	EA	1.81	



MH-D03 **SOCKET CAP STEEL SCREWS - METRIC**

MH-D03002	3 x 6 SOCKET CAP STEEL	EA	0.12	
MH-D03003	3 x 10 SOCKET CAP STEEL	EA	0.11	
MH-D03005	3 x 12 SOCKET CAP STEEL	EA	0.07	
MH-D03007	3 x 16 SOCKET CAP STEEL	EA	0.14	
MH-D03011	3 x 20 SOCKET CAP STEEL	EA	0.07	
MH-D03014	3 x 30 SOCKET CAP STEEL	EA	0.16	
MH-D03017	4 x 6 SOCKET CAP STEEL	EA	0.06	

Code **Product** **Unit** **Std. cost**

MH-D03020	4 x 10 SOCKET CAP STEEL	EA	0.06	
MH-D03023	4 x 12 SOCKET CAP STEEL	EA	0.12	
MH-D03026	4 x 16 SOCKET CAP STEEL	EA	0.15	



MH-D03029	4 x 20 SOCKET CAP STEEL	EA	0.05	
MH-D03032	4 x 25 SOCKET CAP STEEL	EA	0.13	
MH-D03035	4 x 30 SOCKET CAP STEEL	EA	0.09	
MH-D03038	4 x 40 SOCKET CAP STEEL	EA	0.20	
MH-D03041	5 x 10 SOCKET CAP STEEL	EA	0.15	
MH-D03044	5 x 12 SOCKET CAP STEEL	EA	0.16	
MH-D03047	5 x 16 SOCKET CAP STEEL	EA	0.09	
MH-D03050	5 x 20 SOCKET CAP STEEL	EA	0.06	
MH-D03053	5 x 25 SOCKET CAP STEEL	EA	0.20	
MH-D03056	5 x 30 SOCKET CAP STEEL	EA	0.09	
MH-D03059	5 x 40 SOCKET CAP STEEL	EA	0.15	



MH-D03062	5 x 45 SOCKET CAP STEEL	EA	0.31	
MH-D03065	5 x 50 SOCKET CAP STEEL	EA	0.09	
MH-D03068	6 x 10 SOCKET CAP STEEL	EA	0.07	
MH-D03071	6 x 12 SOCKET CAP STEEL	EA	0.20	
MH-D03074	6 x 16 SOCKET CAP STEEL	EA	0.12	
MH-D03077	6 x 20 SOCKET CAP STEEL	EA	0.10	
MH-D03084	6 x 25 SOCKET CAP STEEL	EA	0.14	
MH-D03088	6 x 30 SOCKET CAP STEEL	EA	0.26	
MH-D03089	6 x 35 SOCKET CAP STEEL	EA	0.21	
MH-D03093	6 x 40 SOCKET CAP STEEL	EA	0.20	
MH-D03096	6 x 45 SOCKET CAP STEEL	EA	0.20	







MH-D03099	6 x 50 SOCKET CAP STEEL	EA	0.20	
MH-D03102	6 x 55 SOCKET CAP STEEL	EA	0.32	
MH-D03105	6 x 60 SOCKET CAP STEEL	EA	0.30	
MH-D03108	8 x 10 SOCKET CAP STEEL	EA	0.15	
MH-D03111	8 x 12 SOCKET CAP STEEL	EA	0.25	
MH-D03114	8 x 15 SOCKET CAP STEEL	EA	0.10	
MH-D03117	8 x 20 SOCKET CAP STEEL	EA	0.38	
MH-D03120	8 x 25 SOCKET CAP STEEL	EA	0.26	
MH-D03123	8 x 30 SOCKET CAP STEEL	EA	0.30	
MH-D03126	8 x 35 SOCKET CAP STEEL	EA	0.29	
MH-D03129	8 x 40 SOCKET CAP STEEL	EA	0.15	



MH-D03132	8 x 45 SOCKET CAP STEEL	EA	0.36	
MH-D03135	8 x 50 SOCKET CAP STEEL	EA	0.30	
MH-D03138	8 x 55 SOCKET CAP STEEL	EA	0.41	
MH-D03139	8 x 75 SOCKET CAP STEEL	EA	0.26	
MH-D03141	10 x 12 SOCKET CAP STEEL	EA	0.56	
MH-D03144	10 x 16 SOCKET CAP STEEL	EA	0.18	
MH-D03147	10 x 20 SOCKET CAP STEEL	EA	0.19	



Code **Product** **Unit** **Std. cost**

MH-D03150	10 x 25 SOCKET CAP STEEL	EA	0.37	
MH-D03153	10 x 30 SOCKET CAP STEEL	EA	0.30	
MH-D03156	10 x 35 SOCKET CAP STEEL	EA	0.42	
MH-D03159	10 x 40 SOCKET CAP STEEL	EA	0.32	



MH-D03162	10 x 50 SOCKET CAP STEEL	EA	0.29	
MH-D03165	10 x 60 SOCKET CAP STEEL	EA	0.82	
MH-D03168	10 x 65 SOCKET CAP STEEL	EA	0.77	
MH-D03171	10 x 70 SOCKET CAP STEEL	EA	0.88	
MH-D03174	10 x 75 SOCKET CAP STEEL	EA	0.73	
MH-D03177	12 x 20 SOCKET CAP STEEL	EA	0.43	
MH-D03180	12 x 25 SOCKET CAP STEEL	EA	0.56	
MH-D03183	12 x 30 SOCKET CAP STEEL	EA	0.56	
MH-D03186	12 x 35 SOCKET CAP STEEL	EA	0.61	
MH-D03189	12 x 40 SOCKET CAP STEEL	EA	1.08	
MH-D03192	12 x 45 SOCKET CAP STEEL	EA	0.72	



MH-D03195	12 x 50 SOCKET CAP STEEL	EA	1.46	
MH-D03198	12 x 60 SOCKET CAP STEEL	EA	0.92	
MH-D03201	12 x 75 SOCKET CAP STEEL	EA	0.83	



MH-D04 COUNTER SUNK SOCKET CAP STEEL SCREWS

MH-D04002	3 x 25 CSK. SOCKET CAP STEEL	EA	0.08	
MH-D04004	4 x 10 CSK. SOCKET CAP STEEL	EA	0.11	
MH-D04008	4 x 20 CSK. SOCKET CAP STEEL	EA	0.05	
MH-D04011	4 x 30 CSK. SOCKET CAP STEEL	EA	0.07	
MH-D04014	5 x 10 CSK. SOCKET CAP STEEL	EA	0.06	
MH-D04017	5 x 16 CSK. SOCKET CAP STEEL	EA	0.12	
MH-D04020	5 x 25 CSK. SOCKET CAP STEEL	EA	0.05	



MH-D04023	6 x 10 CSK. SOCKET CAP STEEL	EA	0.04	
MH-D04026	6 x 16 CSK. SOCKET CAP STEEL	EA	0.04	
MH-D04027	6 x 25 CSK. SOCKET CAP STEEL	EA	0.09	
MH-D04028	6 x 30 CSK. SOCKET CAP STEEL	EA	0.29	
MH-D04029	6 x 35 CSK. SOCKET CAP STEEL	EA	0.09	
MH-D04030	6 x 45 CSK. SOCKET CAP STEEL	EA	0.77	
MH-D04032	8 x 10 CSK. SOCKET CAP STEEL	EA	0.46	
MH-D04035	8 x 16 CSK. SOCKET CAP STEEL	EA	0.30	
MH-D04038	8 x 25 CSK. SOCKET CAP STEEL	EA	0.08	
MH-D04040	8 x 35 CSK. SOCKET CAP STEEL	EA	0.18	
MH-D04041	8 x 45 CSK. SOCKET CAP STEEL	EA	0.90	



MH-D04042	10 x 12 CSK. SOCKET CAP STEEL	EA	0.99	
MH-D04044	10 x 25 CSK. SOCKET CAP STEEL	EA	0.32	
MH-D04047	10 x 40 CSK. SOCKET CAP STEEL	EA	0.19	

MH-D05 SOCKET GRUB STEEL SCREWS

MH-D05002	3 x 6 SOCKET GRUB STEEL	EA	0.06	
-----------	-------------------------	----	------	--

Code	Product	Unit	Std. cost	
-------------	----------------	-------------	------------------	--

MH-D05005	3 x 10 SOCKET GRUB STEEL	EA	0.04	
MH-D05008	3 x 12 SOCKET GRUB STEEL	EA	0.22	
MH-D05010	3 x 16 SOCKET GRUB STEEL	EA	0.25	
MH-D05013	4 x 10 SOCKET GRUB STEEL	EA	0.12	
MH-D05016	4 x 12 SOCKET GRUB STEEL	EA	0.37	
MH-D05019	4 x 16 SOCKET GRUB STEEL	EA	0.46	



MH-D05021	4 x 20 SOCKET GRUB STEEL	EA	0.08	
MH-D05025	5 x 10 SOCKET GRUB STEEL	EA	0.13	
MH-D05028	5 x 12 SOCKET GRUB STEEL	EA	0.14	
MH-D05031	5 x 16 SOCKET GRUB STEEL	EA	0.24	
MH-D05034	5 x 20 SOCKET GRUB STEEL	EA	0.11	
MH-D05037	5 x 25 SOCKET GRUB STEEL	EA	0.32	
MH-D05040	6 x 10 SOCKET GRUB STEEL	EA	0.14	
MH-D05043	6 x 12 SOCKET GRUB STEEL	EA	0.14	
MH-D05046	6 x 16 SOCKET GRUB STEEL	EA	0.19	
MH-D05049	6 x 20 SOCKET GRUB STEEL	EA	0.17	
MH-D05052	6 x 25 SOCKET GRUB STEEL	EA	0.22	



MH-D05054	8 x 8 SOCKET GRUB STEEL	EA	0.14	
MH-D05058	8 x 12 SOCKET GRUB STEEL	EA	0.17	
MH-D05061	8 x 16 SOCKET GRUB STEEL	EA	0.06	
MH-D05064	8 x 20 SOCKET GRUB STEEL	EA	0.24	
MH-D05067	8 x 25 SOCKET GRUB STEEL	EA	0.30	
MH-D05070	8 x 30 SOCKET GRUB STEEL	EA	0.41	
MH-D05073	10 x 16 SOCKET GRUB STEEL	EA	0.29	
MH-D05076	10 x 20 SOCKET GRUB STEEL	EA	0.32	
MH-D05079	10 x 25 SOCKET GRUB STEEL	EA	0.39	
MH-D05082	12 x 20 SOCKET GRUB STEEL	EA	0.58	
MH-D05085	12 x 50 SOCKET GRUB STEEL	EA	1.30	



MH-D06 **PAN HEAD STEEL SCREWS - METRIC**

MH-D06013	3 x 12 PAN HEAD STEEL	EA	0.08	
MH-D06016	3 x 25 PAN HEAD STEEL	EA	0.05	
MH-D06019	3 x 50 PAN HEAD STEEL	EA	0.19	
MH-D06025	3.5 x 20 PAN HEAD STEEL	EA	0.14	
MH-D06028	3.5 x 25 PAN HEAD STEEL	EA	0.17	
MH-D06031	3.5 x 50 PAN HEAD STEEL	EA	0.24	
MH-D06034	4 x 12 PAN HEAD STEEL	EA	0.05	
MH-D06036	4 x 16 PAN HEAD STEEL	EA	0.13	
MH-D06039	4 x 20 PAN HEAD STEEL	EA	0.05	
MH-D06042	4 x 25 PAN HEAD STEEL	EA	0.05	
MH-D06045	4 x 50 PAN HEAD STEEL	EA	0.09	





MH-D06048	5 x 12 PAN HEAD STEEL	EA	0.08	
-----------	-----------------------	----	------	---

Code	Product	Unit	Std. cost	
MH-D06052	5 x 16 PAN HEAD STAINLESS STEEL	EA	0.05	
MH-D06055	5 x 20 PAN HEAD STEEL	EA	0.06	
MH-D06058	5 x 25 PAN HEAD STEEL	EA	0.05	
MH-D06061	5 x 30 PAN HEAD STAINLESS STEEL	EA	0.07	
MH-D06064	5 x 35 PAN HEAD STEEL	EA	0.30	
MH-D06067	5 x 50 PAN HEAD STEEL	EA	0.06	
MH-D06070	6 x 12 PAN HEAD STEEL	EA	0.11	
MH-D06073	6 x 16 PAN HEAD STEEL	EA	0.10	
MH-D06076	6 x 20 PAN HEAD STEEL	EA	0.20	



MH-D06079	6 x 25 PAN HEAD ZINC PLATED	EA	0.29	
MH-D06082	6 x 30 PAN HEAD STAINLESS STEEL	EA	0.36	
MH-D06085	6 x 35 PAN HEAD STEEL	EA	0.41	
MH-D06088	6 x 40 PAN HEAD STEEL	EA	0.20	
MH-D06091	6 x 45 PAN HEAD STEEL	EA	0.30	
MH-D06094	6 x 50 PAN HEAD STEEL	EA	0.42	
MH-D06097	8 x 16 PAN HEAD STAINLESS STEEL	EA	0.72	
MH-D06100	8 x 20 PAN HEAD STAINLESS STEEL	EA	0.72	
MH-D06103	8 x 25 PAN HEAD STEEL	EA	0.73	
MH-D06106	8 x 30 PAN HEAD STEEL	EA	0.82	



MH-D06109	8 x 40 PAN HEAD STEEL	EA	0.87	
MH-D06112	8 x 60 PAN HEAD STAINLESS	EA	1.30	
MH-D06115	8 x 100 PAN HEAD STAINLESS STEEL	EA	2.72	



MH-D07 CHEESE HEAD STEEL SCREWS - METRIC

MH-D07008	3 x 12 CHS. HEAD STEEL running down	EA	0.05	
MH-D07017	3.5 x 12 CHS. HEAD STEEL running down	EA	0.14	
MH-D07020	3.5 x 20 CHS. HEAD STEEL running down	EA	0.14	
MH-D07023	3.5 x 25 CHS. HEAD STEEL running down	EA	0.12	
MH-D07026	3.5 x 50 CHS. HEAD STEEL running down	EA	0.12	
MH-D07035	4 x 20 CHS. HEAD STEEL running down	EA	0.10	
MH-D07038	4 x 25 CHS. HEAD STEEL running down	EA	0.10	





MH-D07044	5 x 16 CHS. HEAD STEEL running down	EA	0.14	
MH-D07047	5 x 20 CHS. HEAD STEEL running down	EA	0.10	
MH-D07053	5 x 30 CHS. HEAD STEEL running down	EA	0.12	
MH-D07059	5 x 50 CHS. HEAD STEEL running down	EA	0.14	
MH-D07065	6 x 20 CHS. HEAD STEEL running down	EA	0.14	





Code **Product** **Unit** **Std. cost**

MH-D07068	6 x 25 CHS. HEAD STEEL running down	EA	0.09	
MH-D07071	6 x 50 CHS. HEAD STEEL running down	EA	0.13	

MH-D08 **COUNTER SUNK HEAD STEEL SCREWS - METRIC**

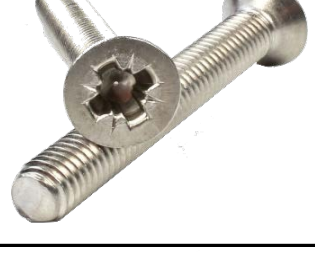
MH-D08018	3 x 12 CSK. HEAD STEEL	EA	0.04	
MH-D08024	3 x 50 CSK. HEAD STEEL	EA	0.24	



MH-D08030	3.5 x 10 CSK. HEAD STEEL	EA	0.05	
MH-D08033	3.5 x 20 CSK. HEAD STEEL	EA	0.06	
MH-D08036	3.5 x 25 CSK. HEAD STEEL	EA	0.10	
MH-D08039	3.5 x 50 CSK. HEAD STEEL	EA	0.17	
MH-D08045	4 x 16 CSK.HEAD STEEL	EA	0.05	
MH-D08048	4 x 20 CSK.HEAD STEEL	EA	0.06	
MH-D08051	4 x 25 CSK. HEAD STEEL	EA	0.04	
MH-D08054	4 x 50 CSK. HEAD STEEL	EA	0.06	
MH-D08057	5 x 12 CSK. HEAD STEEL	EA	0.07	
MH-D08060	5 x 16 CSK. HEAD STEEL	EA	0.07	



MH-D08063	5 x 20 CSK. HEAD STEEL	EA	0.12	
MH-D08066	5 x 25 CSK. HEAD STEEL	EA	0.07	
MH-D08069	5 x 30 CSK. HEAD STAINLESS STEEL	EA	0.20	
MH-D08072	5 x 35 CSK. HEAD STEEL	EA	0.09	
MH-D08075	5 x 50 CSK. HEAD STEEL	EA	0.09	
MH-D08078	6 x 12 CSK. HEAD STEEL	EA	0.09	
MH-D08081	6 x 16 CSK. HEAD STEEL	EA	0.07	
MH-D08084	6 x 20 CSK. HEAD STEEL	EA	0.10	
MH-D08087	6 x 25 CSK. HEAD STEEL	EA	0.32	
MH-D08090	6 x 30 CSK. HEAD STEEL	EA	0.10	









MH-D08093	6 x 35 CSK. HEAD STEEL	EA	0.32	
MH-D08096	6 x 40 CSK. HEAD STEEL	EA	0.54	
MH-D08099	6 x 45 CSK. HEAD STEEL	EA	0.46	
MH-D08102	6 x 50 CSK. HEAD STEEL	EA	0.49	
MH-D08108	8 x 20 CSK. HEAD STAINLESS STEEL	EA	1.29	
MH-D08111	8 x 25 CSK. HEAD STAINLESS STEEL	EA	0.66	
MH-D08112	8 x 30 CSK. HEAD STAINLESS STEEL	EA	0.75	
MH-D08114	8 x 35 CSK. HEAD STEEL	EA	0.13	
MH-D08117	8 x 40 CSK. HEAD STAINLESS STEEL	EA	0.90	
MH-D08120	8 x 45 CSK. HEAD STEEL	EA	0.48	



MH-D08123	10 x 40 CSK. HEAD STAINLESS STEEL	EA	1.45	
-----------	-----------------------------------	----	------	---

MH-D09 BOLTS - METRIC

MH-D09002	6 x 25mm HEXAGON HEAD BOLT	EA	0.20	
MH-D09004	6 x 30mm HEXAGON HEAD BOLT	EA	0.06	
MH-D09006	6 x 35mm HEXAGON HEAD BOLT	EA	0.10	
MH-D09008	6 x 40mm HEXAGON HEAD BOLT	EA	0.07	

<u>Code</u>	<u>Product</u>	<u>Unit</u>	<u>Std. cost</u>	
MH-D09010	6 x 45mm HEXAGON HEAD BOLT	EA	0.17	
MH-D09012	6 x 50mm HEXAGON HEAD BOLT	EA	0.14	
MH-D09014	6 x 55mm HEXAGON HEAD BOLT	EA	0.14	
MH-D09016	6 x 60mm HEXAGON HEAD BOLT	EA	0.14	



MH-D09018	6 x 65mm HEXAGON HEAD BOLT	EA	0.36	
MH-D09020	6 x 70mm HEXAGON HEAD BOLT	EA	0.10	
MH-D09022	6 x 75mm HEXAGON HEAD BOLT	EA	0.25	
MH-D09030	8 x 30mm HEXAGON HEAD BOLT	EA	0.23	
MH-D09032	8 x 35mm HEXAGON HEAD BOLT	EA	0.17	
MH-D09034	8 x 40mm HEXAGON HEAD BOLT	EA	0.19	
MH-D09036	8 x 45mm HEXAGON HEAD BOLT	EA	0.17	
MH-D09038	8 x 50mm HEXAGON HEAD BOLT	EA	0.27	
MH-D09040	8 x 55mm HEXAGON HEAD BOLT	EA	0.19	
MH-D09042	8 x 60mm HEXAGON HEAD BOLT	EA	0.28	



MH-D09044	8 x 65mm HEXAGON HEAD BOLT	EA	0.32	
MH-D09046	8 x 70mm HEXAGON HEAD BOLT	EA	0.27	
MH-D09048	8 x 75mm HEXAGON HEAD BOLT	EA	0.50	
MH-D09050	8 x 80mm HEXAGON HEAD BOLT	EA	0.54	
MH-D09052	8 x 90mm HEXAGON HEAD BOLT	EA	0.36	
MH-D09054	8 x 100mm HEXAGON HEAD BOLT	EA	1.17	
MH-D09060	10 x 35mm HEXAGON HEAD BOLT	EA	0.37	
MH-D09062	10 x 40mm HEXAGON HEAD BOLT	EA	0.34	
MH-D09064	10 x 45mm HEXAGON HEAD BOLT	EA	0.37	
MH-D09066	10 x 50mm HEXAGON HEAD BOLT	EA	0.32	



MH-D09068	10 x 55mm HEXAGON HEAD BOLT	EA	0.25	
MH-D09070	10 x 60mm HEXAGON HEAD BOLT	EA	0.44	
MH-D09072	10 x 65mm HEXAGON HEAD BOLT	EA	0.77	
MH-D09074	10 x 70mm HEXAGON HEAD BOLT	EA	0.53	
MH-D09076	10 x 75mm HEXAGON HEAD BOLT	EA	0.54	
MH-D09080	10 x 90mm HEXAGON HEAD BOLT	EA	0.65	
MH-D09082	10 x 100mm HEXAGON HEAD BOLT	EA	0.84	
MH-D09090	12 x 40mm HEXAGON HEAD BOLT	EA	0.37	
MH-D09092	12 x 45mm HEXAGON HEAD BOLT	EA	0.48	
MH-D09094	12 x 50mm HEXAGON HEAD BOLT	EA	0.44	



MH-D09096	12 x 60mm HEXAGON HEAD BOLT	EA	0.58	
MH-D09098	12 x 65mm HEXAGON HEAD BOLT	EA	0.51	
MH-D09100	12 x 70mm HEXAGON HEAD BOLT	EA	0.68	
MH-D09102	12 x 75mm HEXAGON HEAD BOLT	EA	0.84	
MH-D09104	12 x 80mm HEXAGON HEAD BOLT	EA	0.82	
MH-D09106	12 x 90 mm HEXAGON HEAD BOLT	EA	0.66	
MH-D09108	12 x 100mm HEXAGON HEAD BOLT	EA	0.97	
MH-D09110	12 x 110mm HEXAGON HEAD BOLT	EA	0.96	
MH-D09120	16 x 55mm HEXAGON HEAD BOLT	EA	1.32	
MH-D09122	16 x 60mm HEXAGON HEAD BOLT	EA	0.88	











Code**Product****Unit Std. cost**

MH-D09124	16 x 70mm HEXAGON HEAD BOLT	EA	1.00	
MH-D09126	16 x 75mm HEXAGON HEAD BOLT	EA	1.21	
MH-D09128	16 x 80mm HEXAGON HEAD BOLT	EA	1.35	
MH-D09130	16 x 90mm HEXAGON HEAD BOLT	EA	0.95	
MH-D09132	16 x 100mm HEXAGON HEAD BOLT	EA	1.32	
MH-D09140	20 x 80mm HEXAGON HEAD BOLT	EA	0.82	
MH-D09142	20 x 100mm HEXAGON HEAD BOLT	EA	2.50	
MH-D09144	20 x 150mm HEXAGON HEAD BOLT	EA	3.17	
MH-D09150	24 x 150mm HEXAGON HEAD BOLT	EA	5.12	

MH-D10 COACH BOLTS - METRIC

MH-D10000	M6 x 30 COACH BOLT	EA	0.24	
-----------	--------------------	----	------	---



MH-D10001	M6 x 50 COACH BOLT	EA	0.29	
MH-D10003	M6 x 65 COACH BOLT	EA	0.34	
MH-D10005	M6 x 75 COACH BOLT	EA	0.36	
MH-D10006	M8 x 50 COACH BOLT	EA	0.42	
MH-D10007	M8 x 65 COACH BOLT	EA	0.56	
MH-D10009	M8 x 75 COACH BOLT	EA	0.56	
MH-D10011	M8 x 100 COACH BOLT	EA	0.89	
MH-D10013	M10 x 50 COACH BOLT	EA	0.36	
MH-D10015	M12 x 110 COACH BOLT	EA	1.20	
MH-D10017	M12 x 120 COACH BOLT (RUNNING DOWN)	EA	0.68	





[MH-D15](#) [PAN HEAD BRASS - METRIC](#)

MH-D15001	1.6 x 12 PAN HEAD BRASS	EA	0.14	
MH-D15011	3 x 25 PAN HEAD NICKEL PLATED BRASS	EA	0.17	
MH-D15013	3 x 50 PAN HEAD BRASS	EA	0.20	
MH-D15015	3.5 x 12 PAN HEAD BRASS	EA	0.10	
MH-D15017	3.5 x 20 PAN HEAD BRASS	EA	0.10	
MH-D15019	3.5 x 25 PAN HEAD BRASS	EA	0.09	
MH-D15021	3.5 x 50 PAN HEAD BRASS	EA	0.10	
MH-D15023	4 x 12 PAN HEAD BRASS	EA	0.14	
MH-D15025	4 x 16 PAN HEAD BRASS	EA	0.20	
MH-D15027	4 x 20 PAN HEAD BRASS	EA	0.30	





MH-D15028	4 x 25 PAN HEAD BRASS	EA	0.32	
MH-D15029	4 x 50 PAN HEAD BRASS	EA	0.40	
MH-D15031	5 x 12 PAN HEAD BRASS	EA	0.32	
MH-D15033	5 x 16 PAN HEAD BRASS	EA	0.42	
MH-D15035	5 x 20 PAN HEAD BRASS	EA	0.48	
MH-D15037	5 x 25 PAN HEAD BRASS	EA	0.53	
MH-D15039	5 x 30 PAN HEAD BRASS	EA	0.62	

Code **Product** **Unit** **Std. cost**

MH-D15041	5 x 35 PAN HEAD BRASS	EA	0.19	
MH-D15043	5 x 50 PAN HEAD BRASS	EA	0.80	
MH-D15045	6 x 12 PAN HEAD BRASS	EA	0.56	



MH-D15047	6 x 20 PAN HEAD BRASS	EA	0.15	
MH-D15049	6 x 25 PAN HEAD BRASS	EA	0.65	
MH-D15051	6 x 50 PAN HEAD BRASS	EA	1.33	

MH-D16 CHEESE HEAD BRASS / NYLON - METRIC

MH-D16004	2.5 x 6 CHS. HEAD BRASS running down	EA	0.30	
MH-D16005	2.5 x 12 CHS. HEAD BRASS running down	EA	0.20	
MH-D16006	2.5 x 25 CHS. HEAD BRASS running down	EA	0.05	
MH-D16008	3 x 25 CHS. HEAD BRASS running down	EA	0.10	
MH-D16009	3 x 50 CHS. HEAD BRASS running down	EA	0.20	
MH-D16010	3.5 x 12 CHS. HEAD BRASS running down	EA	0.14	
MH-D16011	3.5 x 20 CHS. HEAD BRASS running down	EA	0.14	





MH-D16012	3.5 x 25 CHS. HEAD BRASS running down	EA	0.14	
MH-D16013	3.5 x 50 CHS. HEAD BRASS running down	EA	0.08	
MH-D16015	4 x 16 CHS. HEAD BRASS running down	EA	0.20	
MH-D16016	4 x 20 CHS. HEAD BRASS running down	EA	0.14	
MH-D16017	4 x 25 CHS. HEAD BRASS running down	EA	0.14	
MH-D16018	4 x 50 CHS. HEAD BRASS running down	EA	0.12	
MH-D16020	5 x 16 CHS. HEAD BRASS running down	EA	0.08	





MH-D16022	5 x 25 CHS. HEAD BRASS running down	EA	0.20	
MH-D16023	5 x 30 CHS. HEAD BRASS running down	EA	0.14	
MH-D16024	5 x 35 CHS. HEAD BRASS running down	EA	0.20	
MH-D16025	5 x 50 CHS. HEAD BRASS running down	EA	0.12	
MH-D16027	6 x 25 CHS. HEAD BRASS running down	EA	0.03	
MH-D16028	6 x 50 CHS. HEAD BRASS running down	EA	0.19	

MH-D17 COUNTER SUNK HEAD BRASS - METRIC

MH-D17003	2.5 x 25 CSK. HEAD BRASS running down	EA	0.03	
MH-D17005	3 x 25 CSK. HEAD BRASS running down	EA	0.12	



MH-D17007	3.5 x 12 CSK. HEAD BRASS running down	EA	0.14	
MH-D17008	3.5 x 20 CSK. HEAD BRASS running down	EA	0.27	
MH-D17009	3.5 x 25 CSK. HEAD BRASS running down	EA	0.20	

<u>Code</u>	<u>Product</u>	<u>Unit</u>	<u>Std. cost</u>	
MH-D17010	3.5 x 50 CSK. HEAD BRASS running down	EA	0.27	
MH-D17012	4 x 16 CSK. HEAD BRASS running down	EA	0.05	
MH-D17014	4 x 25 CSK. HEAD BRASS running down	EA	0.08	
MH-D17015	4 x 50 CSK. HEAD BRASS running down	EA	0.12	
MH-D17016	6 x 50 CSK. HEAD BRASS running down	EA	0.61	
MH-D17017	5 x 16 CSK. HEAD BRASS running down	EA	0.14	



MH-D17019	5 x 25 CSK. HEAD BRASS running down	EA	0.20	
MH-D17020	5 x 35 CSK. HEAD BRASS running down	EA	0.20	
MH-D17022	6 x 12 CSK. HEAD BRASS running down	EA	0.42	
MH-D17023	6 x 25 CSK. HEAD BRASS running down	EA	0.30	
MH-D17024	6 x 50 CSK. HEAD BRASS running down	EA	0.85	



MH-D18 SET SCREWS HEX HEAD BRASS

MH-D18001	2.5 x 25 HEX. HEAD BRASS	EA	0.08	
MH-D18003	3 x 12 HEX. HEAD BRASS	EA	0.34	
MH-D18004	3 x 25 HEX. HEAD BRASS	EA	0.20	
MH-D18006	4 x 16 HEX. HEAD BRASS	EA	0.12	



MH-D18007	4 x 25 HEX. HEAD BRASS	EA	0.29	
MH-D18008	4 x 50 HEX. HEAD BRASS	EA	0.51	
MH-D18009	5 x 12 HEX. HEAD BRASS	EA	0.22	
MH-D18010	5 x 16 HEX. HEAD BRASS	EA	0.25	
MH-D18011	5 x 25 HEX. HEAD BRASS	EA	0.44	
MH-D18012	5 x 50 HEX. HEAD BRASS	EA	0.48	
MH-D18020	6 x 50 HEX. HEAD BRASS	EA	0.56	
MH-D18030	10 x 25 HEX. HEAD BRASS	EA	0.85	

MH-D32 SCREWED ROD STEEL & BRASS - METRIC

MH-D32005	3mm SCREWED BRASS ROD	EA	6.74	
MH-D32006	3mm SCREWED STEEL ROD	EA	4.68	







MH-D32007	3.5mm SCREWED BRASS ROD RUNNING DOWN	EA	3.60	
MH-D32009	4mm SCREWED BRASS ROD	EA	9.50	
MH-D32010	4mm SCREWED STEEL ROD	EA	1.68	
MH-D32011	5mm SCREWED BRASS ROD	EA	9.22	
MH-D32012	5mm SCREWED STEEL ROD	EA	1.82	
MH-D32013	6mm SCREWED BRASS ROD	EA	10.23	
MH-D32014	6mm SCREWED STEEL ROD	EA	2.09	





Code **Product** **Unit** **Std. cost**

MH-D32015	8mm SCREWED BRASS ROD	EA	32.50	
MH-D32016	8mm SCREWED STEEL ROD	EA	2.38	
MH-D32017	10mm SCREWED BRASS ROD	EA	49.95	



MH-D32018	10mm SCREWED STEEL ROD	EA	3.14	
MH-D32019	12mm SCREWED BRASS ROD	EA	64.19	
MH-D32020	12mm SCREWED STEEL ROD	EA	4.87	
MH-D32021	16mm SCREWED STEEL ROD	EA	9.71	
MH-D32022	20mm SCREWED STEEL ROD	EA	17.53	

MH-D33 SCREWED ROD STAINLESS - METRIC

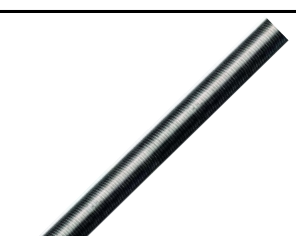
MH-D33005	5mm SCREWED STAINLESS STEEL ROD	EA	6.82	
MH-D33006	6mm SCREWED STAINLESS STEEL ROD	EA	7.27	
MH-D33007	8mm SCREWED STAINLESS STEEL ROD	EA	8.32	
MH-D33010	10mm SCREWED STAINLESS STEEL ROD	EA	16.04	
MH-D33015	12mm SCREWED STAINLESS STEEL ROD	EA	22.85	





MH-D33020	16mm SCREWED STAINLESS STEEL ROD	EA	44.37	
-----------	----------------------------------	----	-------	---



MH-D34 SCREWED ROD STEEL & BRASS BSF [RUNNING DOWN]

MH-D34002	1/4" BSF SCREWED STEEL ROD	EA	2.14	
MH-D34003	5/16" BSF SCREWED BRASS ROD	EA	5.74	
MH-D34004	5/16" BSF SCREWED STEEL ROD	EA	6.00	
MH-D34005	3/8" BSF SCREWED BRASS ROD	EA	5.90	
MH-D34008	7/16" BSF SCREWED STEEL ROD	EA	3.12	
MH-D34016	7/8" BSF SCREWED STEEL ROD	EA	4.94	





MH-D35 SCREWED ROD STEEL & BRASS BSW RUNNING DOWN

MH-D35006	3/8" BSW SCREWED STEEL ROD	EA	1.78	
MH-D35010	3/4" BSW SCREWED STEEL ROD	EA	7.99	





MH-D35011	7/8" BSW SCREWED STEEL ROD	EA	4.63	
MH-D35013	1 1/8" BSW SCREWED STEEL ROD	EA	6.67	





MH-D36 SCREWED ROD STEEL & BRASS BA RUNNING DOWN

MH-D36004	4BA SCREWED BRASS ROD	EA	4.25	
MH-D36005	4BA SCREWED STEEL ROD	EA	2.53	
MH-D36006	6BA SCREWED BRASS ROD	EA	7.41	
MH-D36007	6BA SCREWED STEEL ROD	EA	4.83	

Code Product Unit Std. cost**MH-37 SCREWED ROD STEEL & BRASS UNF RUNNING DOWN**

MH-D37002	5/16" UNF SCREWED STEEL ROD	EA	5.14	
MH-D37004	7/16" UNF SCREWED STEEL ROD	EA	5.14	

**MH-D40 RIVETS**

MH-D40029	(Box) 2.4mm x 5.0mm ALUMINIUM POP RIVETS	BOX	6.45	
MH-D40030	(PACK) 3.2 x 8.0mm ALUMINIUM POP RIVET	PK	12.15	
MH-D40032	(PACK) 4.0 x 14.0mm DOME ALUMINIUM POP RIVET	PK	3.73	
MH-D40033	(PACK) 4.8 x 11.9mm ALUMINIUM POP RIVET	PK	6.04	
MH-D40034	4.8 x 19.0mm ALUMINIUM POP RIVET	EA	0.19	











L2 STORES CATALOGUE

WASHERS - E



Code **Product** **Unit** **Std. cost**

E **WASHERS - BRASS / STEEL / STAINLESS STEEL**

MH-E01 **PLAIN STEEL WASHERS - METRIC**

MH-E01002	2.0mm PLAIN STEEL WASHER	EA	0.02	
MH-E01004	2.5mm PLAIN STEEL WASHER	EA	0.02	
MH-E01008	3.0mm PLAIN STEEL WASHER	EA	0.02	
MH-E01009	4.0mm PLAIN STEEL WASHER	EA	0.03	
MH-E01011	5.0mm PLAIN STEEL WASHER	EA	0.03	
MH-E01013	6.0mm PLAIN STEEL WASHER	EA	0.02	
MH-E01015	8.0mm PLAIN STEEL WASHER	EA	0.08	
MH-E01017	10.0mm PLAIN STEEL WASHER	EA	0.14	
MH-E01019	12.0mm PLAIN STEEL WASHER	EA	0.06	



MH-E01021	16.0mm PLAIN STEEL WASHER	EA	0.16	
MH-E01023	20.0mm PLAIN STEEL WASHER	EA	0.20	
MH-E01024	24.0mm PLAIN STEEL WASHER	EA	0.49	

MH-E02 **STEEL SPRING WASHERS - METRIC**

MH-E02004	3.5mm SPRING WASHER	EA	0.03	
MH-E02006	5.0mm SPRING WASHER	EA	0.02	
MH-E02008	6.0mm SPRING WASHER	EA	0.03	
MH-E02010	8.0mm SPRING WASHER	EA	0.04	
MH-E02012	10.0mm SPRING WASHER	EA	0.10	
MH-E02014	12.0mm SPRING WASHER	EA	0.17	
MH-E02016	16.0mm SPRING WASHER	EA	0.39	





L2 STORES CATALOGUE



WASHERS - E

MH-E02018	20.0mm SPRING WASHER	EA	0.64	
-----------	----------------------	----	------	---



MH-E03 STEEL SHAKE PROOF WASHERS - METRIC

MH-E03004	3.5mm SHAKE PROOF WASHER RUNNING DOWN	EA	0.03	
MH-E03006	5.0mm SHAKE PROOF WASHER	EA	0.02	
MH-E03008	6.0mm SHAKE PROOF WASHER	EA	0.02	
MH-E03010	8.0mm SHAKE PROOF WASHER	EA	0.04	
MH-E03012	10.0mm SHAKE PROOF WASHER	EA	0.05	
MH-E03014	12.0mm SHAKE PROOF WASHER	EA	0.07	



MH-E04 MUDGUARD WASHERS STEEL - METRIC

MH-E04006	5mm MUDGUARD WASHER	EA	0.02	
MH-E04008	6mm MUDGAURD WASHER	EA	0.02	







MH-E04010	8mm MUDGUARD WASHER	EA	0.02	
MH-E04016	10mm MUDGUARD WASHER	EA	0.05	

MH-E05 STAINLESS WASHERS - METRIC

MH-E05001	4.0mm STAINLESS WASHER	EA	0.09	
MH-E05002	5.0mm STAINLESS WASHER	EA	0.09	

Code**Product****Unit****Std. cost**

MH-E05003	6.0mm STAINLESS WASHER	EA	0.08	
MH-E05006	8.0mm STAINLESS WASHER	EA	0.14	
MH-E05008	10.0mm STAINLESS WASHER	EA	0.09	
MH-E05010	12.0mm STAINLESS WASHER	EA	0.54	

MH-E06 BRASS WASHERS - METRIC

MH-E06008	3.0mm BRASS WASHER	EA	0.02	
-----------	--------------------	----	------	---



MH-E06009	3.5mm BRASS WASHER RUNNING DOWN	EA	0.05	
MH-E06010	4.0mm BRASS WASHER	EA	0.05	
MH-E06011	5.0mm BRASS WASHER	EA	0.04	
MH-E06013	6.0mm BRASS WASHER	EA	0.11	
MH-E06015	8.0mm BRASS WASHER	EA	0.13	
MH-E06017	10.0mm BRASS WASHER	EA	0.25	



L2 STORES CATALOGUE

NUTS - F

Code **Product** **Unit** **Std. cost**

F **NUTS BRASS / STEEL / STAINLESS STEEL**

MH-F01 **NUTS ALL MATERIALS - METRIC**

MH-F01006	2.0mm STEEL NUT	EA	0.15	
MH-F01008	2.0mm BRASS NUT	EA	0.05	
MH-F01010	2.5mm STEEL NUT	EA	0.15	
MH-F01012	2.5mm BRASS NUT	EA	0.03	
MH-F01014	3.0mm STEEL NUT	EA	0.03	
MH-F01016	3.0mm BRASS NUT NICKEL PLATED	EA	0.04	
MH-F01018	3.0mm STEEL WING NUT	EA	0.17	
MH-F01020	3.0mm NYLOC NUT	EA	0.13	
MH-F01022	3.5mm STEEL NUT	EA	0.03	



L2 STORES CATALOGUE

NUTS - F

MH-F01024	3.5mm BRASS NUT	EA	0.03	
MH-F01026	4.0mm STEEL NUT	EA	0.15	
MH-F01028	4.0mm BRASS NUT	EA	0.15	
MH-F01030	4.0mm STAINLESS NUT	EA	0.15	
MH-F01032	4.0mm STEEL WINGNUT	EA	0.17	
MH-F01034	4.0mm BRASS WINGNUT	EA	0.27	
MH-F01036	4.0mm NYLOC NUT	EA	0.15	
MH-F01038	5.0mm STEEL NUT	EA	0.15	
MH-F01040	5.0mm BRASS NUT	EA	0.15	
MH-F01042	5.0mm STAINLESS NUT	EA	0.15	



L2 STORES CATALOGUE

NUTS - F

MH-F01044	5.0mm STEEL WINGNUT	EA	0.17	
MH-F01046	5.0mm BRASS WINGNUT	EA	0.15	
MH-F01048	5.0mm NYLOC STEEL NUT	EA	0.15	
MH-F01052	6.0mm STEEL NUT	EA	0.03	
MH-F01054	6.0mm BRASS NUT	EA	0.15	
MH-F01056	6.0mm STAINLESS NUT	EA	0.05	
MH-F01058	6.0mm STEEL WINGNUT	EA	0.14	
MH-F01060	6.0mm NYLOC NUT	EA	0.13	
MH-F01062	8.0mm STEEL NUT	EA	0.15	
MH-F01064	8.0mm BRASS NUT	EA	0.15	









MH-F01066	8.0mm STAINLESS NUT	EA	0.32	
MH-F01068	8.0mm STEEL WINGNUT	EA	0.17	
MH-F01070	8.0mm BRASS WINGNUT	EA	0.17	
MH-F01072	8.0mm NYLOC NUT	EA	0.15	
MH-F01076	10.0mm STEEL NUT	EA	0.15	
MH-F01078	10.0mm BRASS NUT	EA	0.44	
MH-F01080	10.0mm STAINLESS NUT	EA	0.20	
MH-F01082	10.0mm STEEL WINGNUT	EA	0.12	
MH-F01084	10.0mm NYLOC NUT	EA	0.11	
MH-F01086	12.0mm STEEL NUT	EA	0.15	







L2 STORES CATALOGUE

NUTS - F

MH-F01088	12.0mm STAINLESS NUT	EA	0.99	
MH-F01090	12.0mm STEEL WINGNUT	EA	0.99	

<u>Code</u>	<u>Product</u>	<u>Unit</u>	<u>Std. cost</u>	
MH-F01092	12.0mm NYLOC NUT BZP	EA	0.22	
MH-F01094	16.0mm STEEL NUT	EA	0.27	
MH-F01096	20.0mm STEEL NUT	EA	0.46	
MH-F01098	24.0mm STEEL NUT	EA	1.54	

MH-F02 ASSORTED HELICOIL / NUTCERTS & HANK BRUSHES

MH-F02020	6mm STEEL NUTCERT	EA	0.14	
MH-F02022	8mm STEEL NUTCERT	EA	0.19	
MH-F02030	1/4" BSF HELICOIL INSERT	EA	0.42	
MH-F02040	4mm HELICOIL STEEL INSERT	EA	0.37	



MH-F02042	5mm HELICOIL STEEL INSERT	EA	0.44	
MH-F02044	6mm HELICOIL STEEL INSERT	EA	0.50	
MH-F02046	8mm HELICOIL STEEL INSERT	EA	0.48	
MH-F02048	10mm HELICOIL STEEL INSERT	EA	0.48	



L2 STORES CATALOGUE

ADHESIVES / SEALANTS - G

Code **Product** **Unit** **Std. cost**



G **TAPES / ADHESIVES / SEALANTS**

MR-G01 **ADHESIVE TAPES**

MR-G01001	50mm DOUBLE SIDED ADHESIVE TAPE	EA	29.18	
MR-G01002	25mm DOUBLE SIDED ADHESIVE TAPE	EA	3.93	
MR-G01003	(5 Metre Reel of) 20mm CUSHIONED TAPE	EA	5.49	
MR-G01004	1" MASKING TAPE	EA	0.78	
MR-G01005	2" MASKING TAPE	EA	1.86	
MR-G01006	PTFE TAPE	EA	0.41	
MR-G01007	2" HAZARD WARNING TAPE (B/Y)	EA	10.78	
MR-G01008	75mm HAZARD TAPE NOT ADHESIVE (B/Y)	EA	6.43	
MR-G01009	2" SILVER GAFFER TAPE	EA	21.43	
MR-G01010	BROWN PARCEL TAPE	EA	2.88	
MR-G01011	HI-BOND POLYIMIDE TAPE 25.0MM-HEAT RESISTANT	EA	38.69	



MG-G02 **ADHESIVES**





MR-G02003	LOCTITE 270 STUDLOCK 10ml	EA	17.75	
MR-G02004	20ml LOCTITE ADHESIVE [480]	EA	29.14	
MR-G02005	LOCTITE FLANGE SEALANT [574]	EA	31.69	
MR-G02007	LOCTITE THREAD SEALANT [572]	EA	25.82	
MR-G02009	LOCTITE HI STGH RETAINER[638 was 601] 10ml	EA	11.25	
MR-G02011	LOCTITE BEARING FIT RETAINER [641] 10ml	EA	12.96	
MR-G02022	LOCTITE SUPER GLUE	EA	3.88	
MR-G02026	EVO-STIK IMPACT ADHESIVE 250ml	EA	7.87	
MR-G02027	EVO-STIK IMPACT LARGE 67 G	EA	6.12	
MR-G02029	40ml THIXOFIX IMPACT	EA	4.32	
MR-G02033	EVO-STIK WOOD ADHESIVE - BLUE	EA	15.01	
MR-G02035	EVO-STIK WOOD FAST - GREEN	EA	7.14	









MR-G02040	EPOXY RAPID SET ADHESIVE	EA	6.84	
MR-G02041	DOUBLE BUBBLE EPOXY (RUNNING DOWN)	EA	2.03	
MR-G02042	PRECISION HEAVY/DUTY EXPOXY	EA	6.84	
MR-G02044	24ml ARALDITE CLEAR SYRINGE	EA	10.75	
MR-G02045	NO MORE NAILS UNIBOND	EA	3.75	
MR-G02046	BOSTIK GENERAL PURPOSE	EA	2.82	
MR-G02047	SPRAY ADHESIVE [SA90]	EA	16.14	

MR-G03 SEALANTS

MR-G03001	SEALANT GUN LARGE	EA	5.61	
-----------	-------------------	----	------	---

Code	Product	Unit	Std. cost	
MR-G03003	SEALANT WHITE	EA	10.60	
MR-G03006	SEALANT CLEAR	EA	5.10	
MR-G03007	SEALANT GREY	EA	4.69	
MR-G03009	SEALANT BLACK	EA	12.08	



MR-G03010	SEALANT MATRIX 500 FAST CURE GREY	EA	9.48	
MR-G03015	SEALANT WHITE OIL BASE	EA	14.15	
MR-G03018	SEALANT ROOF AND GUTTER BLACK	EA	3.27	
MR-G03026	SILICON RUBBER COMPOUND	EA	13.12	
MR-G03040	FILLER	EA	10.06	
MR-G03042	EXPANDING FOAM AEROSOL	EA	9.56	



L2 STORES CATALOGUE

CUTTING FLUID / PASTE - H



Code **Product** **Unit** **Std. cost**

H **CUTTING FLUID / PASTE**



VG-H01 **CUTTING FLUIDS**

VG-H01004	METAL & CUTTING SPRAY	EA	13.53	
VG-H01005	ROCOL V-CUT SS BARREL	EA	230.00	
VG-H01008	ROCOL V-CUT EP BARREL	EA	211.92	

VG-H02 **CUTTING COMPOUNDS**

VG-H02001	STAG JOINTING COMPOUND A 400G	EA	26.76	
VG-H02002	STAG JOINTING COMPOUND B 500G	EA	40.00	
VG-H02003	TREFOLEX CUTTING COMPOUND	EA	18.50	

VG-H03 **GREASE**

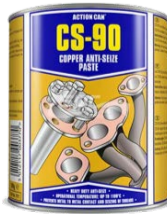
VG-H03000	CASTROL GEN PUR LITHIUM GREASE 400G	EA	4.33	
VG-H03001	50 ml MULTI-PURPOSE GREASE	EA	2.83	
VG-H03002	CS-90 COPPER ANTI-SIEZE PASTE	EA	10.05	



VG-H03003	HEAT SINK GREASE	EA	33.11	
-----------	------------------	----	-------	---



L2 STORES CATALOGUE

OILS/LUBRICANTS/CLEANERS - I

<u>Code</u>	<u>Product</u>	<u>Unit</u>	<u>Std. cost</u>	
I	<u>OILS / LUBRICANTS / CLEANERS</u>			
VG-I01	<u>OILS</u>			
VG-I01001	CASTROL VG32 HYD (replaces VITREA 32)	L	5.30	
VG-I01004	CASTROL HYPIN AWS46	L	4.22	
VG-I01005	CASTROL HYPIN AWS32	L	4.22	
VG-I01006	CASTROL HYPIN AWS 100	L	4.75	
VG-I01007	CASTROL MAGNA BD68 SLIDEWAY OIL	L	6.63	
VG-I01008	CASTROL HYPIN AWS 68	L	4.65	
VG-I01010	CASTROL ALPHA SP150 (GEAR OIL)	L	5.16	
VG-I01011	RANDO HD68 GEAR OIL(RUNNING DOWN)USE I01010	L	2.38	
VG-I01014	SPECIAL CASTROL MAGNA 2 (ANTI WEAR)	L	5.71	
VG-I01016	SPECIAL CASTROL MAGNA 100 (GEARBOX OIL)	L	4.19	





VG-I02 **LUBRICANT SPRAYS**

VG-I02003	WD40	EA	7.48	
-----------	------	----	------	---







L2 STORES CATALOGUE

OILS/LUBRICANTS/CLEANERS - I

VG-I02004	AMBERSIL PENETRATING OIL	EA	9.28	
VG-I02005	PLASTICINE GREY 500G PACK	EA	1.29	
VG-I02006	SHOCK FREEZE RELEASE SPRAY	EA	9.52	
VG-I02007	AMBERKLENE FE10 DEGREASER SPRAY	EA	12.37	
VG-I02011	AMBERSIL CCL100 MOULD RELEASE	EA	8.15	

VG-I03 CLEANERS

VG-I03003	400ml FOAM CLEANER SPRAY	EA	8.77	
VG-I03004	AMBERSIL CONTACT CLEANER	EA	8.95	
VG-I03005	B-CLEAN LENS CLEANER SPRAY	EA	5.38	
VG-I03006	ULTRAGAURD-SC SYS CLEANER	EA	245.62	
VG-I03013	METAL POLISH BRASSO	EA	7.10	

VG-I04 DEGREASERS

VG-I04002	SWARFEGA BIODEGRADABLE DEGREASER 5 LTR	EA	36.85	
-----------	--	----	-------	---



L2 STORES CATALOGUE

PAINT / BRUSHES - J









Product

Unit

Std. cost







PAINT / VARNISH / INK / BRUSHES

AEROSOL PAINTS

Product	Unit	Std. cost		
WC-J01001	EA	7.11		
WC-J01002	EA	7.35		
WC-J01003	EA	18.50		
WC-J01004	EA	15.09		
WC-J01005	EA	10.57		
WC-J01006	EA	11.00		
WC-J01007	EA	10.57		
WC-J01009	EA	12.22		
WC-J01010	EA	9.91		
WC-J01011	EA	10.53		
WC-J01012	EA	16.38		
WC-J01015	EA	9.70		

L2 STORES CATALOGUE

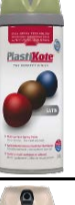

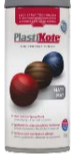
PAINT / BRUSHES - J

WC-J01017	PORCELAIN AEROSOL PAINT SATIN R/ DOWN	EA	9.16		
WC-J01019	WINE RED AEROSOL PAINT SATIN R/DOWN	EA	9.16		
WC-J01021	REAL RED AEROSOL PAINT SATIN R/DOWN	EA	9.16		
WC-J01025	PISTACHIO AEROSOL PAINT SATIN R/DOWN	EA	9.16		
WC-J01027	EVERGLADE AEROSOL PAINT SATIN R/DOWN	EA	9.16		
WC-J01029	WARM GREY AEROSOL PAINT SATIN R/DOWN	EA	9.16		
WC-J01030	CHOCOLATE AEROSOL PAINT MATT R/DOWN	EA	9.16		

PAINT & VARNISH TINS











WC-J02007	750ML HAMMERITE METAL - BLACK	EA	35.74		
WC-J02012	ZINC GALV	EA	17.54		
WC-J02016	RUSTOLEUM PAINT STRIPPER	EA	23.15		

BRUSHES & TURPS



WC-J03002	1/2" PAINT BRUSH INDUSTRIAL	EA	0.43		
WC-J03003	1" PAINT BRUSH INDUSTRIAL	EA	0.94		

L2 STORES CATALOGUE

PAINT / BRUSHES - J

WC-J03004	1 1/2" PAINT BRUSH INDUSTRIAL	EA	0.81		
WC-J03005	2" PAINT BRUSH INDUSTRIAL	EA	1.28		
	Product	Unit	Std. cost		
WC-J03006	2.5" PAINT BRUSH PROFESSIONAL	EA	1.69		
WC-J03007	ARTISTS TOUCH-UP BRUSH ECONOMY	EA	0.45		
WC-J03009	1" PAINT BRUSH PROFFESIONAL	EA	2.02		
WC-J03010	1 1/2" PAINT BRUSH ECONOMY	EA	2.00		
WC-J03011	2" PAINT BRUSH ECONOMY	EA	2.60		
WC-J03012	3" PAINT BRUSH ECONOMY	EA	2.55		
WC-J03013	2ltr WHITE SPIRIT	EA	5.24		
WC-J03014	4ltr WHITE SPIRIT	EA	10.33		

MARKER INKS

WC-J04002	ENGINEERS BLUE INK - AEROSOL	EA	39.91		
WC-J04003	MARKAL BALL PAINT MARKER YELLOW	EA	8.32		







L2 STORES CATALOGUE

SAFETY EQUIPMENT - K



Code **Product** **Unit** **Std. cost**

K **SAFETY EQUIPMENT**

UK-K01 **EYE PROTECTION**

UD-K01001	I-VOSUPRAVISION SAFETY SPECS	EA	10.43		
UD-K01002	OVER SPECTACLES AURORA	EA	1.36		
UD-K01004	STUDENT SPECS/SECURE FIT	EA	5.17		
UD-K01009	FACE GUARD GOGGLE ANTI SCRATCH	EA	11.54		
UD-K01010	LENS CLEANING WIPE BOX OF 100	EA	9.97		
UD-K01013	WELDING SPECTACLES	EA	13.80		
UD-K01019	FLIP UP WELDING GOGGLE PARWELD	EA	7.20		

UD-K02 **EAR PROTECTION**

UD-K02001	MOLDEX MELLOWS STATION EAR PLUGS PACK OF 500	EA	80.10		
UD-K02003	3M EAR DEFENDER PELTOR X1A	EA	19.98		

UD-K03 **HAND PROTECTION**





L2 STORES CATALOGUE

SAFETY EQUIPMENT - K

UD-K03003	POLYCHEM GAUNTLET RED/BLUE CHEM RESISTANT	EA	2.39		
UD-K03004	POLYCO ANTI VIBRATION GLOVE PAIR	EA	22.71		
UD-K03006	HYFLEX GREY NYLON LINE GLOVE SIZE 9	EA	5.23		
UD-K03007	KEVLAR GLOVES	EA	22.79		
UD-K03011	NITRILE GLOVE SKYTEC UTAH SMALL	BOX	21.00		
UD-K03012	NITRILE GLOVE SKYTEC UTAH MED	BOX	21.01		
UD-K03013	NITRILE GLOVE SKYTEC UTAH LARGE	BOX	21.01		
UD-K03014	NITRILE GLOVE SKYTEC UTAH XL	BOX	21.00		
UD-K03016	ANSELL ACTIVARMOR ORANGE GLOVE SIZE 9	PAIR	22.51		
UD-K03017	H/D NITRILE COATED S/C GLOVE BLUE SZ.10	PAIR	17.72		
UD-K03018	BLUE OPTIMA RUBBER GLOVE	PAIR	2.10		

L2 STORES CATALOGUE



SAFETY EQUIPMENT - K

UD-K03019	BLACK NEOPRENE CHEMICAL RESISTANT GLOVE	PAIR	5.07		
UD-K03021	WELDERS GAUNTLETS	PAIR	7.38		
UD-K03022	TIG WELDING GLOVES SOFT	PAIR	3.78		
UD-K03023	GOJO NATURAL SCRUB HAND CLEANER	EA	19.38		
UD-K03024	LIQUID HAND SOAP	L	6.60		
UD-K03025	GO JO HAND MEDIC	EA	11.76		

UD-K04 RESPIRATORY PROTECTION





UD-K04001	3M DUST MASK FFP3 8835	EA	7.62		
-----------	------------------------	----	------	---	--

Code **Product** **Unit** **Std. cost**

UD-K04007	FT-11 SENSITIVITY TEST SOLUTION - SWEET	EA	21.86		
UD-K04008	FT-32 FIT TEST SOLUTION - BITTER	EA	21.72		





L2 STORES CATALOGUE

SAFETY EQUIPMENT - K

UD-K04009	FT-12 FIT TEST SOLUTION - SWEET	EA	23.06		
UD-K04011	3M 4279 RESPIRATOR	EA	27.28		
UD-K04013	3M DUST MASK FFP3 9332+	EA	7.07		
UD-K04015	FACE FIT TEST KIT 3M	EA	193.06		



UD-K05

WIPES

UD-K05000	(Pack of 5) 320 x 340mm WIPER SHEET SAFE CLOTH	PCK	24.82		
UD-K05002	BIG WIPES HAND WIPER BUCKET	EA	18.94		
UD-K05006	BIG WIPES INDUSTRIAL POWER SPRAY 1L	EA	17.98		

L2 STORES CATALOGUE





SAFETY EQUIPMENT - K

UD-K05003	10" TORK BLUE WIPES	EA	3.00		
UD-K05004	2 PLY BLUE BUMPER ROLL SOLENT	EA	14.34		
UD-K05005	BLEACHED 18" TACK CLOTHS BOX OF 50	EA	24.25		

UD-K06000	STOCKINETTE ROLL POLISH CLOTH	EA	8.14		
UD-K06003	15 LTR SPILL KIT FOR SOLVENTS, COOLANT, OILS	EA	33.21		
UD-K06004	10kg RAG BAG	EA	10.38		
UD-K06005	TYVEC PRO-TECH COVERALL/HD M	EA	3.09		
UD-K06006	TYVEC PRO-TECH COVERALL LARGE	EA	7.97		
UD-K06007	TYVEC PRO-TECH COVERALL/HD XL	EA	5.20		
UD-K06008	LAB COATS EXTRA SMALL	EA	13.64		

L2 STORES CATALOGUE



SAFETY EQUIPMENT - K

UD-K06008L	LAB COAT, LADIES X-SMALL	EA	13.64		
UD-K06009	LAB COAT SMALL	EA	13.67		
UD-K06010	LAB COAT MEDIUM	EA	13.64		
UD-K06011	LAB COAT LARGE,	EA	13.64		
UD-K06011XL	LAB COAT XL	EA	13.64		
UD-K06011XXL	LAB COAT XXL	EA	13.64		
UD-K06011C	LAB COAT XXXL	EA	13.64		
UD-K06012	PLASTIC DUSTPAN & BRUSH	EA	4.05		
UD-K06013	METAL DUSTPAN	EA	5.50		
UD-K06014	BENCH HAND BRUSH SOFT BRISTLE	EA	2.30		
UD-K06015	EQUIPMENT SPRAY BOTTLES WHITE	EA	8.30		

L2 STORES CATALOGUE

SAFETY EQUIPMENT - K

UD-K06016	VARIOUS SIZE TOP PLASTIC FUNNEL	EA	0.97		
UD-K06017	2 LITRE MEASURE JUG POLY	EA	8.23		
UD-K06018	MOP HEAD	EA	4.02		
UD-K06019	12" BRUSH HEAD (SOFT)	EA	3.91		
UD-K06020	24" PLATFORM BRUSH AND STAY	EA	15.00		
UD-K06021	BRUSH/MOP HANDLES	EA	4.50		
UD-K06022	12" BRUSH HEAD STIFF BRISTLE	EA	5.50		
UD-K06024	ABSORBENT GRANULES	PCK	8.64		
UD-K06032	20 LITRE WATER CONTAINER	EA	15.91		
UD-K06033	68 LITRE EURO NESTING BIN & LID	EA	39.56		

<u>Code</u>	<u>Product</u>	<u>Unit</u>	<u>Std. cost</u>		
UD-K06036	RUNING DOWN LAB COATS PLASTIC FOLD FLAT TROLLEY	EA	48.09		



L2 STORES CATALOGUE

SAFETY EQUIPMENT - K

UD-K06037	STEELITE PROTECTOR WORK BOOT (SIZES 1-13)	EA	21.56		
UD-K06038	JSP COMFORT RATCHETED SAFETY HELMET	EA	5.86		
UD-K06040	HI VIS VEST WAISTCOAT YELLOW BAND	EA	5.09		
UD-K06041	ROYAL BLUE AEROSPACE LAB COAT S	EA	11.81		
UD-K06042	ROYAL BLUE AEROSPACE LAB COAT M	EA	11.81		
UD-K06043	ROYAL BLUE AEROSPACE LAB COAT L	EA	11.81		
UD-K06044	ROYAL BLUE AEROSPACE LAB COAT XL	EA	11.81		
UD-K06045	ROYAL BLUE AEROSPACE LAB COAT XS	EA	11.81		
UD-K06086	LADIES LAB COAT SMALL FACULTY LOGO	EA	13.64		
UD-K06086A	LADIES LAB COAT X SMALL FACULTY LOGO	EA	13.64		
UD-K06087	LADIES LAB COAT MED FACULTY LOGO	EA	13.64		

L2 STORES CATALOGUE

SAFETY EQUIPMENT - K

UD-K06088	LADIES LAB COAT LARGE FACULTY LOGO	EA	13.64		
UD-K06089	LADIES LAB COAT XL FACULTY LOGO	EA	13.64		





L2 STORES CATALOGUE



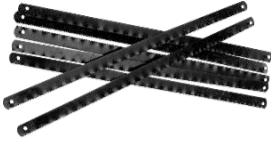
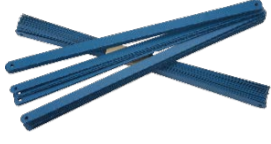

SAWS - L

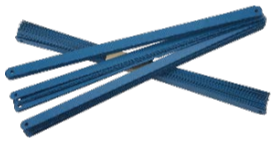
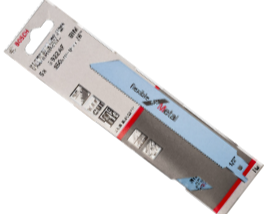
Code **Product** **Unit** **Std. cost**

L
MQ-L01 **SAWS**
HACKSAW BLADES





MQ-L01000	6" x 1/4" x 32 tpi JUNIOR HACKSAW BLADE	EA	0.26		
MQ-L01001	10" x 1/2" x 24 tpi HACKSAW BLADE	EA	1.04		
MQ-L01003	12" x 1/2" x 14 tpi HACKSAW BLADE	EA	1.13		
MQ-L01005	12" x 1/2" x 18 tpi HACKSAW BLADE	EA	1.04		
MQ-L01009	12" x 1/2" x 32 tpi HACKSAW BLADE	EA	2.20		
MQ-L01012	150MM BOSCH RECIPROCATING SAW BLADE	PCK	19.98		

MQ-L02 **JIGSAW BLADES**



MQ-L02002	JIGSAW BLADE [T118 TYPE] (PACK OF 5)	PCK	7.19		
MQ-L02004	2.5mm PITCH JIGSAW BLADE [T101BR] (PACK OF 5)	PCK	7.62		
MQ-L02006	4.0mm PITCH JIGSAW BLADE [T144D] (PACK OF 5)	PCK	7.50		

L2 STORES CATALOGUE



SAWS - L

MQ-L02008	JIGSAW BLADE [T119B BOSCH] (PACK OF 5)	PCK	5.84		
MQ-L02010	2.0mm PITCH JIGSAW BLADE [T318B] (PACK OF 5)	PCK	9.82		
MQ-L02012	4.0mm PITCH JIGSAW BLADE [T101D] (PACK OF 5)	PCK	8.82		
MQ-L02014	1.5 - 4mm PITCH JIGSAW BLADE [T118A] (PACK OF 3)	PCK	2.90		

MQ-L03 BAND SAW BLADES

MQ-L03029	15 2" x 3/4" 6-10 VARI PITCH PRO M42 BS BLADE	EA	79.70		
MQ-L03030	11 11" x 1" 5-8 VARI PITCH BANDSAW BLADE	EA	34.84		
MQ-L03031	11 11" X 1" 6-10 VARI PITCH BANDSAW BLADE	EA	78.13		
MQ-L03033	2910 X 0.9 X 27MM 6-10 VERSATIX BANDSAW BLADE	EA	63.80		

MQ-L04 HOLE SAWS & ARBORS

MQ-L04002	16mm HOLES AW CUTTER	EA	8.87		
Code	Product	Unit	Std. cost		
MQ-L04004	20mm HOLES AW CUTTER	EA	11.06		

L2 STORES CATALOGUE

SAWS - L

MQ-L04006	25mm HOLES AW BLADE	EA	11.35		
MQ-L04008	50mm HOLES AW BLADE	EA	11.35		
MQ-L04010	76mm ROEBUCK HOLES AW	EA	14.84		
MQ-L04014	SMALL 14 - 30mm HOLES AW ARBOR	EA	9.15		
MQ-L04016	MEDIUM 14 - 152mm ROEBUCK ARBOR	EA	19.04		
MQ-L04018	LARGE 76mm HOLES AW JACOB ARBOR	EA	14.31		

MQ-L07 ABRAFILE SAWS & ADAPTORS

MQ-L07001	12" x 300mm ABRAFILE BLADE	EA	4.82		
-----------	----------------------------	----	------	---	--



L2 STORES CATALOGUE

ABRASIVES - M

Code **Product** **Unit** **Std. cost**





M **ABRASIVES**
MH-M01 PFLAP WHEEL / DISCS & SANDING BANDS

MH-M01000	30 x 15mm x 60g FLAP WHEEL	EA	2.76		
MH-M01001	30 x 15mm x 120g FLAP WHEEL	EA	2.50		
MH-M01003	50 x 30mm x 40g FLAP WHEEL	EA	3.45		
MH-M01004	50 x 30mm x 60g FLAP WHEEL	EA	5.46		
MH-M01005	115 x 22mm x 40 grit FLAP DISC	EA	2.50		
MH-M01007	115 x 22mm x 120g FLAP DISC	EA	2.32		
MH-M01009	25 x 25 x 50g SANDING BAND	EA	0.70		
MH-M01011	25 x 25 x 150g SANDING BAND	EA	0.77		
MH-M01013	25 x 25 SANDING BAND ARBOR	EA	8.28		
MH-M01014	80 MESH WATER JET SAND	EA	15.30		

L2 STORES CATALOGUE

ABRASIVES - M

MH-M01016	70mm WIRE BRUSH STAINLESS	EA	18.65		
MH-M01017	S/S SPECIAL END BRUSH	EA	21.29		
MH-M01018	25.0mm ROLOC DISC HOLDER	EA	6.12		
MH-M01019	38.0mm ROLOC DISC HOLDER	EA	6.12		
MH-M01020	50.0mm ROLOC DISC HOLDER	EA	6.12		
MH-M01021	115mm BACKUP PAD M14	EA	24.10		
MH-M01021A	N/GRIP RAPID PREP COARSE 115.0MM BROWN	EA	3.72		
MH-M01021B	EXTRA COARSE N/GRIP RAPID PREP 115 MM MAROON	EA	3.14		
MH-M01021C	MEDIUM N/GRIP RAPID PREP 115.0MM GREEN	EA	3.28		
MH-M01021D	FINE N/GRIP RAPID PREP 115.0MM GREY	EA	3.14		
MH-M01021E	VERY FINE N/GRIP RAPID PREP 115.0MM CREAM	EA	3.28		

MH-M01021F	POLISHING PASTE BAR WHITE	EA	4.43	
MH-M01022	25.0mm ROLOC CLOTH DISC 60 GRIT	EA	0.50	
MH-M01023	38.0mm ROLOC CLOTH DISC 100 GRIT	EA	0.54	
MH-M01025	50.0mm ROLOC CLOTH DISC 60 GRIT	EA	1.08	

MH-M02 GRINDING / SANDING & SLITTING DISCS

MH-M02000	75 x 0.8 x 9.5mm CUT OFF DISC	EA	2.55	
MH-M02001	115 x 1.0mm x 22mm SLITTING DISC	EA	3.34	
MH-M02002	115 x 22 x 36g 3M FIBRE SANDING DISC	EA	1.78	
MH-M02003	115 x 22 x 120g 3M FIBRE SANDING DISC	EA	0.60	
MH-M02004	115 x 2.5 x 22mm CUTTING DISC	EA	2.30	
MH-M02010	115 x 6.4 x 22mm GRINDING DISC	EA	1.83	



L2 STORES CATALOGUE

ABRASIVES - M

MH-M02017	180 x 3.2 x 22mm STONE CUTTING DISC	EA	1.44	
MH-M02020	230 x 3.2 x 22mm STONE CUT OFF DISC	EA	3.91	
MH-M02024	180 x 2.5 x 22mm CUTTING DISC	EA	3.17	
MH-M02025	180 x 6 x 22mm GRINDING DISC	EA	2.48	
MH-M02040	230 x 3 x 22mm METAL CUTTING DISC	EA	2.02	

MH-M03 WIRE WOOL & FINISHING PADS

MH-M03002	WIRE WOOL GRADE 0 (FINE)	PCK	10.24	
MH-M03004	WIRE WOOL GRADE 1-2 (MEDIUM)	PCK	2.55	
MH-M03006	WIRE WOOL GRADE 4 (COARSE)	PCK	5.60	
MH-M03010	GEN.PURP FINISHING PADS GREEN	EA	2.59	
MH-M03012	FIBRAL HAND PADS XX FINE	EA	2.23	



L2 STORES CATALOGUE

ABRASIVES - M

MH-M03014	HAND PADS COARSE BROWN	EA	4.63		
-----------	------------------------	----	------	---	--

<u>Code</u>	<u>Product</u>	<u>Unit</u>	<u>Std. cost</u>		
<u>MH-M04</u>	<u>WET & DRY PAPER / EMERY ROLL / EMERY BELTS</u>				

MH-M04018	WET AND DRY PAPER 220 GRIT	SHT	0.71		
MH-M04020	WET & DRY PAPER (400 grain)	SHT	0.41		
MH-M04022	WET & DRY PAPER (500 grain)	SHT	0.63		
MH-M04024	WET & DRY PAPER (600 grain)	SHT	1.19		
MH-M04026	WET & DRY PAPER (1000 grain)	SHT	0.63		
MH-M04030	25mm EMERY TAPE (40 grain)	EA	27.00		
MH-M04031	25mm EMERY TAPE COARSE GRIT	EA	29.80		
MH-M04032	25mm EMERY TAPE (80 grain)	EA	24.79		
MH-M04035	25mm EMERY TAPE (100 grain)	EA	31.75		

L2 STORES CATALOGUE

ABRASIVES - M

MH-M04036	25mm x 50 MTS EMERY TAPE (medium grain)	EA	20.43		
MH-M04038	3M 25mm x 25m EMERY TAPE (240 grain)	EA	27.83		
MH-M04042	1.5 GRADE 120 GRITSAND PAPER	SHT	0.97		
MH-M04044	SAND PAPER 40 GRADE	SHT	1.75		
MH-M04050	LINISHER BELT P40 (VERY COARSE)	EA	5.30		
MH-M04052	LINISHER BELT P60 (COARSE)	EA	5.08		
MH-M04053	LINISHER BELT P80 (MEDIUM)	EA	6.73		
MH-M04058	LINISHER BELT P60 G 1220 x 150 AXMINSTER	EA	13.00		
MH-M04059	LINISHER BELT P120G 1220 x 150 AXMINSTER	EA	10.05		
MH-M04060	(Pack of 5) LINISHER DISC P80 250mm AXMINSTER	PCK	30.28		
MH-M04062	(Pack of 2) LINISHER DISC P240 250mm AXMINSTER	PCK	12.13		









L2 STORES CATALOGUE

HOSE ACCESSORIES - N

Code **Product** **Unit** **Std. cost**

N **HOSE & ACCESSORIES/PIPE INSULATION**

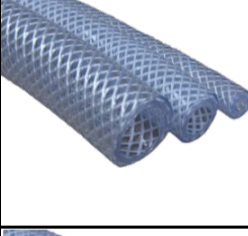
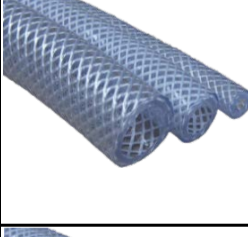
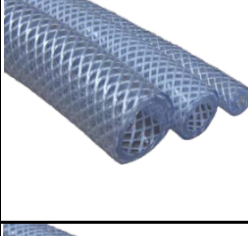
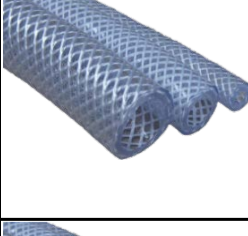
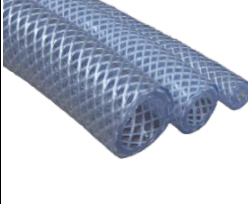
MP-N01 **CLEAR HOSE**

MP-N01000	3mm ID CLEAR PVC TUBING	M	0.37		
MP-N01005	5mm ID CLEAR PVC TUBING	M	0.51		
MP-N01007	6mm ID CLEAR PVC TUBING	M	0.63		
MP-N01008	8mm ID CLEAR PVC TUBING	M	0.60		
MP-N01010	10mm ID CLEAR PVC TUBING	M	2.59		
MP-N01013	12mm ID CLEAR PVC TUBING	M	2.79		
MP-N01025	5mm ID PVC BRAIDED TUBING	M	0.63		
MP-N01028	6mm ID PVC BRAIDED TUBING	M	1.80		
MP-N01029	8mm ID PVC BRAIDED TUBING	M	1.44		
MP-N01031	10mm ID PVC BRAIDED TUBING	M	3.29		
MP-N01032	12mm ID PVC BRAIDED TUBING	M	3.46		

L2 STORES CATALOGUE



HOSE ACCESSORIES - N

MP-N01033	19mm ID PVC BRAIDED TUBING	M	3.20		

MP-N02 HIGH PRESSURE HOSE

MP-N02002	5mm ID HIGH PRESSURE HOSE	M	2.40		
MP-N02005	6mm ID HIGH PRESSURE HOSE	M	2.74		
MP-N02008	8mm ID HIGH PRESSURE HOSE	M	3.02		
MP-N02010	10mm ID HIGH PRESSURE HOSE	M	3.46		
MP-N02013	13mm ID HIGH PRESSURE HOSE	M	4.75		
MP-N02017	19mm ID HIGH PRESSURE HOSE	M	6.34		

MP-N03 AIRLINE FITTINGS



MP-N03002	9.5mm HOSETAIL-STANDARD MALE COUPLING	EA	0.96		
MP-N03005	STANDARD AIRLINE TWIN COUPLING	EA	43.29		

L2 STORES CATALOGUE

HOSE ACCESSORIES - N





MP-N03008	6.35mm HOSETAIL-STANDARD MALE COUPLING	EA	0.96		
MP-N03012	1/4" BSPP FEMALE-STANDARD MALE COUPLING	EA	0.96		
MP-N03014	BLOW GUN WITH SAFETY NOZZLE	EA	7.83		
MP-N03017	1/4" BSPP FEMALE-FEMALE COUPLING	EA	5.67		
MP-N03023	1/4" BSPT MALE-STANDARD MALE COUPLING	EA	0.96		
MP-N03026	1/4" BSPT MALE - 6.3mm HOSETAIL	EA	0.92		
MP-N03027	3/8" BSPT MALE - 12.7mm HOSETAIL	EA	1.45		
MP-N03029	1/4" BSPT MALE - 9.5mm HOSETAIL	EA	0.92		
MP-N03030	1/4" BSPT MALE - 7.9mm HOSETAIL	EA	0.90		
MP-N03033	6.3mm HOSETAIL - 6.3mm HOSETAIL (1/4")	EA	1.97		

Code **Product** **Unit** **Std. cost**
[MP-N04](#) [O CLIPS FOR AIRLINE](#)

MP-N04001	1/4" O CLIP	EA	0.24		
-----------	-------------	----	------	---	---

L2 STORES CATALOGUE

HOSE ACCESSORIES - N

MP-N04003	5/16" O CLIP	EA	0.26		
MP-N04005	7/16" O CLIP	EA	0.33		
MP-N04009	9/16" O CLIP	EA	0.41		
MP-N04011	5/8" O CLIP	EA	0.30		
MP-N04014	20-23mm O CLIP	EA	0.39		

MP-N05

WORM DRIVE JUBILEE CLIPS

MP-N05000	9.5-12mm OOO HOSE CLIP	EA	0.41		
MP-N05001	11-16mm MOO HOSE CLIP	EA	0.43		
MP-N05002	13-19mm OO HOSE CLIP	EA	0.43		
MP-N05003	16-22mm O HOSE CLIP	EA	0.47		
MP-N05005	19-25mm OX HOSE CLIP	EA	0.50		

MP-N05006	22-30mm 1A HOSE CLIP	EA	0.52		
MP-N05007	25-40mm 1 HOSE CLIP STAINLESS	EA	0.56		
MP-N05008	30-40mm 1X HOSE CLIP	EA	0.58		
MP-N05009	35-50mm 2A HOSE CLIP	EA	0.75		
MP-N05010	40-55mm 2 HOSE CLIP	EA	0.77		
MP-N05011	45-60mm 2X HOSE CLIP	EA	1.16		
MP-N05012	55-70mm 3 HOSE CLIP	EA	1.01		
MP-N05013	60-80mm 3X HOSE CLIP	EA	1.09		
MP-N05014	70-90mm 4 HOSE CLIP	EA	1.16		
MP-N05016	85-100mm 4X HOSE CLIP	EA	1.37		
					

MP-N05018	104-127mm 6 HOSE CLIP	EA	1.16		
-----------	-----------------------	----	------	---	--

MP-N07 PNEUMATIC TUBES AND CONSUMABLES

MP-N07010	4.0MM BLACK POLYURETHANE TUBE	REEL	9.75		
MP-N07012	4.0MM STRAIGHT CONNECTOR	EA	2.18		
MP-N07013	4.0MM G 1/8 M/P CONNECTOR	EA	2.02		
MP-N07014	4.0MM G 1/4 M/P CONNECTOR	EA	2.28		
MP-N07015	4.0MM ELBOW CONNECTOR	EA	2.08		
MP-N07016	4.0MM BLANKING PLUG	EA	0.74		
MP-N07017	4.0MM TEE CONNECTOR	EA	2.71		
MP-N07020	6.0MM BLACK POLYURETHANE TUBE	REEL	26.23		
MP-N07022	6.0MM STRAIGHT CONNECTOR	EA	2.09		
MP-N07023	6.0MM G1/8 M/P CONNECTOR	EA	1.75		

L2 STORES CATALOGUE

HOSE ACCESSORIES - N

MP-N07024	6.0MM G1/4 M/P CONNECTOR	EA	3.00		
MP-N07025	6.0MM BLANKING PLUG	EA	0.75		
MP-N07026	6.0MM ELBOW CONNECTOR	EA	2.43		
MP-N07027	6.0MM TEE CONNECTOR	EA	3.99		
MP-N07029	6.0MM REDUCER-4MM STEM	EA	3.17		
MP-N07030	8.0MM BLACK POLYURETHANE TUBE	REEL	37.06		
MP-N07032	8.0MM ELBOW CONNECTOR	EA	2.60		
MP-N07033	8.0MM STRAIGHT CONNECTOR	EA	£2.20		
MP-N07034	8.0MM G1/8 M/P CONNECTOR	EA	2.26		
MP-N07035	8.0MM G1/4 M/P CONNECTOR	EA	5.18		
MP-N07036	Straight Tube-to-Tube Adapter - 8MM to 6MM	EA	5.18		

L2 STORES CATALOGUE

HOSE ACCESSORIES - N

MP-N07037	8.0MM TEE CONNECTOR	EA	3.14		
MP-N07038	8.0MM BLANKING PLUG	EA	1.18		
MP-N07040	10.0MM BLACK POLYURETHANE TUBE	EA	71.98		
MP-N07042	10.0MM CONNECTOR G1/4 M/P	EA	2.05		
MP-N07043	10.0MM CONNECTOR G1/8 M/P	EA	2.37		
MP-N07044	10.0MM ELBOW CONNECTOR	EA	3.76		
MP-N07045	10.0MM BLANKING PLUG	EA	1.75		
MP-N07046	Tube-to-Tube Adapter-10MM to 8MM	EA	3.60		
MP-N07047	10.0MM TEE CONNECTOR	EA	5.61		



L2 STORES CATALOGUE

LAB SUNDRIES I.T. - P

Code **Product** **Unit** **Std. cost**

P **LAB SUNDRIES & I.T.**

MA-P01 **BATTERIES**

MA-P01001	N SIZE BATTERY	EA	1.45		
MA-P01002	AAA BATTERY (MN2400)	EA	1.78		
MA-P01003	AA BATTERY (MN1500)	EA	0.43		
MA-P01004	9 V PP3 BATTERY (MN1604)	EA	2.80		
MA-P01005	C BATTERY (MN1400)	EA	2.10		
MA-P01006	D TYPE BATTERY (MN1300)	EA	1.08		
MA-P01008	CR1616 BATTERY LITHIUM COIN CELL	EA	1.77		
MA-P01009	CR2032 COIN CELL BATTERY	EA	2.36		
MA-P01010	1.5V COIN CELL BATTERY (LR44/D357)	EA	0.70		

MA-P01011	CR2016 COIN CELL BATTERY	EA	3.27		
MA-P01012	LED POCKET TORCH	EA	9.50		
MA-P01012A	LED INSPECTION TORCH (GENERAL LIGHT LED)	EA	9.50		
MA-P01012B	LED KEYRING TORCH	EA	8.50		
MA-P01013	RECHARGABLE AAA BATTERY	EA	6.58		
MA-P01014	4 PACK RECHARGABLE AA NIMH BATTERY	EA	10.00		
MA-P01015	2 PACK CR2 BATTERY	PCK	7.35		
LK-P02	BAGS / BOTTLES / SAMPLE BOXES				
LK-P02001	(Pack of 100) 2 1/4" x 2 1/4" PLAIN GRIPSEAL BAGS	PCK	0.25		
LK-P02002	(Pack of 100) 3" x 3 1/2" PLAIN GRIPSEAL BAGS	PCK	0.63		
LK-P02003	(Pack of 100) 3 1/2" x 4 1/2" PLAIN GRIPSEAL BAGS	PCK	2.22		

L2 STORES CATALOGUE

LAB SUNDRIES I.T. - P

LK-P02004	(Pack of 100) 6" x 9" PLAIN GRIPSEAL BAGS	PCK	3.22		
LK-P02005	BLACK REFUSE BAGS 18" x 29" x 39"	EA	0.27		
LK-P02006	HEAVY DUTY POLY BAG BLUE	EA	0.41		
LK-P02007	BLACK REFUSE BAG 30" x 46" x 54"	PCK	30.00		
LK-P02008	CONFIDENTIAL WASTE BAG YELLOW	EA	0.41		
LK-P02009	32 SECTION SAMPLE BOX (LARGE)	EA	16.95		
LK-P02010	18 SECTION SAMPLE BOX (MEDIUM)	EA	4.07		
LK-P02011	9 SECTION SAMPLE BOX (VARIOUS COMPARTMENTS)	EA	7.72		
LK-P02012	7 SECTION SAMPLE BOX (VARIOUS COMPARTMENTS)	EA	5.80		
LK-P02013	250ml LDPE BLANK LABEL BOTTLE	EA	3.96		
LK-P02014	500ml LDPE I.M.S BOTTLE	EA	4.29		

L2 STORES CATALOGUE

LAB SUNDRIES I.T. - P

LK-P02016	500ml LDPE ACETONE BOTTLE	EA	8.20		
LK-P02020	28ml GLASS SPECIMEN BOTTLE	EA	0.44		
LK-P02022	250ml GLASS REAGENT BOTTLE	EA	1.90		
LK-P02025	150ml GRADUATED BOTTLE AZLON NARROW NECK	EA	1.11		
LK-P02029	500ml GLASS REAGENT BOTTLE	EA	8.57		
LK-P02030	3.2mm SIZAL STRING (2.5KG)	EA	9.21		
LK-P02031	STRETCH WRAP CLEAR	EA	15.64		

Code





Product

Unit

Std. cost











[LK-P03](#)

[METALLURGY](#)

LK-P03003	CHEMICLOTH 254 10" (PACK)	PK	24.91		
LK-P03009	PLANOCLOTH (6um) 8" RUNNING DOWN	EA	8.59		
LK-P03010	ALPHA CLOTH (1um) 8" (PACK)	PK	71.96		





L2 STORES CATALOGUE

LAB SUNDRIES I.T. - P

LK-P03011	PLANOCLOTH (6um) 10" (PACK)	PK	71.96		
LK-P03012	ALPHA CLOTH (1um) 10"(PACK)RUNNING DOWN	PK	91.29		
LK-P03020	MAGNOPLATE (AKA MAGNOMET 200)	EA	8.49		
LK-P03021	8" PAN-W POLISH CLOTH (9 TO 1 MIC)	EA	8.44		
LK-P03023	8" MDCHEM POLISH CLOTH (FINISHING)	EA	42.55		
LK-P03026	10" TEXMET POLISH CLOTH(15 TO 3 MIC)RUN DOWN	PCK	117.61		
LK-P03027	10" MICROCLOTH POLISH CLOTH(3 TO .25 MIC) RUN DOWN	EA	8.16		
LK-P03031	10" TRIDENT PSA POLISH CLOTH (RUNNING DOWN)	EA	12.37		
LK-P03041	3 MICRON DIAMOND SUSPENSION REFILL	EA	174.17		
LK-P03045	MAGNOPLATE 10"	EA	11.17		
					

L2 STORES CATALOGUE

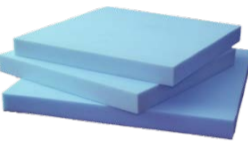
LAB SUNDRIES I.T. - P

LK-P03059	EPOFIX COLD SET RESIN (2 PART)	EA	138.99	
<u>Code</u>	<u>Product</u>	<u>Unit</u>	<u>Std. cost</u>	
LK-P03066	125 x 0.8 x 12.7mm CUT OFF DISC	EA	14.86	
LK-P03067	TYPE T5 TATANIUM, ALI, COPPER 150X0.45X12.7 DISC	EA	16.65	
LK-P03076	160 x 600 x 500mm STYROFOAM BOARD RUNNING DOWN	EA	40.32	
LK-P03079	COMPRESSED AIR CANISTER FG	EA	21.00	

KD-P04 I.T DISCS & PRINTER CARTRIDGES

KD-P04000	16GB KINGSTON USB DATA TRAVELLER	EA	7.08	
KD-P04001	64GB KINGSTON USB 3.0 DATA TRAVELLER	EA	26.71	
KD-P04002	32GB KINGSTON USB DATA TRAVELLER	EA	15.28	
KD-P04006	Kingston 32GB Micro SDHC Card with Adapter(CLASS 10)	EA	19.26	
KD-P04008	LOGITECH KEYBOARD AND MOUSE	EA	23.31	







L2 STORES CATALOGUE

LAB SUNDRIES I.T. - P

KD-PO4017	DVD-R 4.7GB 1-16X INCLUDING DVD CASE	EA	0.52		
-----------	--------------------------------------	----	------	---	--

SZ -P05 STATIONERY

SZ-P05010	DRY WIPE BOARD (900 x 600mm)	EA	14.00		
SZ-P05011	DRY WIPE BOARD (1200 x 900mm)	EA	22.00		
SZ-P05033	FELT NOTICE BOARD BLUE (1200 x 900mm)	EA	21.18		
SZ-P05034	FELT NOTICE BOARD BLUE (900 x 600mm)	EA	10.60		
<u>LK-P06</u>	<u>PLA FILAMENT 3D PRINTING</u>				
LK-P06000	PLA FILAMENT 1KG REEL 1.75MM DIA SILVER	EA	35.59		
LK-P06001	PLA FILAMENT 1KG REEL 1.75MM DIA BLACK	EA	35.59		
LK-P06002	PLA FILAMENT 1KG REEL 1.75MM DIA BLUE	EA	35.59		
LK-P06008	ABS FILAMENT 1KG REEL 1.75MM DIA BLACK	EA	35.59		
LK-P06009	ABS FILAMENT 1KG REEL 1.75MM DIA SILVER	EA	35.59		

LK-P06010	ABS FILAMENT 1KG REEL 1.75MM DIA BLUE	EA	35.59		
LK-P06015	ULTIMAKER PLA FILAMENT .75 KG REEL 2.85MM DIA SILVER	EA	46.06		
LK-P06016	ULTIMAKER PLA FILAMENT .75 KG REEL 2.85MM DIA WHITE	EA	46.06		
LK-P06017	ULTIMAKER PLA FILAMENT .75 KG REEL 2.85MM DIA BLACK	EA	46.06		







L2 STORES CATALOGUE

WELDING WIRE ERODING - Q

Code **Product** **Unit** **Std. cost**

Q **WELDING & WIRE ERODING**





MZ-Q01 **FLUX & SOLDER**

MZ-Q01001	LA-CO FLUX 475g	EA	14.50		
MZ-Q01002	TENACITY 5 HI TEMP FLUX 500g	EA	22.36		
MZ-Q01004	250ml BAKERS FLUID No.3	EA	11.10		
MZ-Q01005	TINMANS SOLDER	EA	9.00		
MZ-Q01007	SOLDER 3.5mm THICK, 60% TIN, 40% LEAD	EA	41.87		

MZ-Q02 **WELDING RODS & WIRE [RUNNING DOWN]**





MZ-Q02056	0.6mm MIG WELDING WIRE NOVAFIL	EA	67.88		

MZ-Q03 **ACCESSORIES**

MZ-Q03001	ANTI-SPATTER AEROSOL	EA	5.83		
MZ-Q03002	LEAK DETECTOR AEROSOL	EA	19.83		
MZ-Q03003	WIRE BRUSH - 4 ROW STAINLESS	EA	9.17		

MZ-Q04

WIRE ERODING PIPE

MZ-Q04001	(Pack of 20) 0.5mm UNI-HOLE ELECTRODE PIPE	PCK	70.50		
MZ-Q04002	(Pack of 20) 0.8mm ELECTRODE PIPE	PCK	75.00		
MZ-Q04004	(Pack of 20) 1.0mm ELECTRODE PIPE	PCK	70.50		
MZ-Q04006	(Pack of 20) 2.0mm ELECTRODE PIPE	PCK	70.50		













L2 STORES CATALOGUE

MISCELLANEOUS ITEMS - R

Code Product Unit Std. cost











R **MISCELLANEOUS ITEMS**

MQ-R01 **MISCELLANEOUS ITEMS**

MQ-R01050	32mm TERRY CLIP	EA	0.82		
MQ-R01052	25mm TERRY CLIP	EA	0.21		
MQ-R01054	19mm TERRY CLIP	EA	0.37		
MQ-R01056	14mm TERRY CLIP	EA	0.37		
MQ-R01058	12mm TERRY CLIP	EA	0.36		
MQ-R01060	6mm TERRY CLIP	EA	0.36		
MQ-R01071	1/16" DIA. STEEL BALL	EA	0.59		
MQ-R01072	1/8" DIA. STEEL BALL	EA	0.35		
MQ-R01073	3/16" DIA. STEEL BALL	EA	0.12		
MQ-R01074	7/32" DIA. STEEL BALL	EA	0.99		
MQ-R01075	1/4" DIA. STEEL BALL	EA	0.17		

L2 STORES CATALOGUE

MISCELLANEOUS ITEMS - R

MQ-R01076	5/16" DIA. STEEL BALL	EA	0.44		
MQ-R01077	3/8" DIA. STEEL BALL	EA	0.59		
MQ-R01078	7/16" DIA. STEEL BALL	EA	0.82		
MQ-R01079	1/2" DIA. STEEL BALL	EA	0.18		
MQ-R01080	1" DIA STEEL BALL	EA	2.40		
MQ-R01081	2mm STEEL BALL (RUNNING DOWN)	EA	0.17		
MQ-R01082	3mm STEEL BALL	EA	0.12		
MQ-R01083	4mm STEEL BALL	EA	0.12		
MQ-R01084	5mm STEEL BALL	EA	0.13		
MQ-R01085	6mm STEEL BALL	EA	0.17		



MQ-R01100	3" STEEL BUTT HINGE (PAIR)	EA	1.14		
MQ-R01103	1 1/2" STEEL BUTT HINGE (PAIR)	EA	4.59		



L2 STORES CATALOGUE



MISCELLANEOUS ITEMS - R

MQ-R01109	4" STEEL BUTT HINGE (PAIR)	EA	2.88		
MQ-R01115	65mm BRASS BUTT HINGES	EA	2.35		
MQ-R01117	2" BRASS BUTT HINGES	EA	3.00		
MQ-R01126	M8 x 25 ANCHOR SHIELD BOLT	EA	2.69		
MQ-R01127	M6 x 20 ANCHOR SHIELD BOLT	EA	1.60		
MQ-R01128	10mm THROUGH BOLT	EA	4.08		
MQ-R01129	6" TOWER BOLT BLACK	EA	4.25		
MQ-R01130	2" STRAIGHT BARREL BOLT	EA	4.29		
MQ-R01134	HD SPRING LOADED BOLT	EA	11.29		
MQ-R01140	WEATHER RESIST PADLOCK L/SHANK 49MM	EA	11.14		

<u>Code</u>	<u>Product</u>	<u>Unit</u>	<u>Std. cost</u>		
MQ-R01141	SLIMLINE BRASS PADLOCK 30MM(STUDENT LOCKERS)	EA	6.59		

L2 STORES CATALOGUE

MISCELLANEOUS ITEMS - R

MQ-R01142	40mm LAMINATED PADLOCKS LONG SHANK	EA	11.70		
MQ-R01143	40mm BRASS PADLOCK	EA	8.42		
MQ-R01144	20mm BRASS PADLOCKS	EA	4.26		
MQ-R01146	50mm BRASS PADLOCK CROSS KEY SECURITY	EA	29.56		
MQ-R01147	30MM TITALIUM HI SECURITY 30MM PADLOCK	EA	10.03		
MQ-R01148	CHAIN HEAVY DUTY	M	4.80		
MQ-R01149	CHAIN MEDIUM DUTY	M	2.03		
MQ-R01150	CHAIN LIGHT DUTY	M	2.35		
MQ-R01151	CHAIN VERY HEAVY DUTY	M	7.10		
MQ-R01196	HASP & STAPLE	EA	5.91		
MQ-R01205	8" x 6" SHELF BRACKET (RUNNING DOWN)	EA	3.46		

[MD-R02](#) [TOOLBOX & CONTENTS](#)













L2 STORES CATALOGUE

MISCELLANEOUS ITEMS - R

MD-R02002	600mm SPIRIT LEVEL	EA	17.48		
MD-R02003	25 PCE DRILLSET GUHRING	EA	35.64		
MD-R02004	4" G CLAMP	EA	15.38		
MD-R02005	6" G CLAMP	EA	28.79		
MD-R02009	150mm/6" COMB.TRY SQUARE	EA	13.52		
MD-R02015	ENGINEERS DATA/REF BOOK	EA	5.55		
MD-R02016	NOGA DEBURR 3 TOOL	EA	13.62		
MD-R02018	THOREX PLASTIC HAMMER 408 250 GRAM	EA	10.53		
MD-R02019	THOREX PLASTIC HAMMER 410 450 GRAM	EA	15.92		
MD-R02020	THOREX PLASTIC INSERTS FOR 410 MALLETT	EA	1.75		
MD-R02022	11 PCE WATCHMAKERS SCREWDRIVER SET	EA	8.42		
MD-R02023	150mm DIGITAL CALIPERS	EA	54.46		

L2 STORES CATALOGUE

MISCELLANEOUS ITEMS - R

MD-R02025	TRIGGER FEED DUAL MELT GUN	EA	11.74		
MD-R02026	CLEAR HOT MELT ADHESIVE STICK 12MM PACK OF 8	PK	4.16		
MD-R02050	5 METRE RULE POWERLOCK	EA	6.45		
MD-R02051	TOOLBOX STANLEY	EA	19.87		
MD-R02052	HACKSAW FRAME WITH BLADE	EA	18.03		
MD-R02053	4" ADJUSTABLE SPANNER	EA	14.28		
MD-R02054	8" ADJUSTABLE SPANNER	EA	21.58		
MD-R02055	SCRIBER	EA	3.77		
MD-R02056	150mm STEEL RULE QUALITY	EA	8.23		
MD-R02057	300mm STEEL RULE QUALITY	EA	14.52		
MD-R02058	8oz BALL PEIN HAMMER	EA	15.03		
MD-R02059	JUNIOR HACKSAW FRAME	EA	8.35		

L2 STORES CATALOGUE

MISCELLANEOUS ITEMS - R



Code	Product	Unit	Std. cost		
MD-R02060	160mm PAIR OF COMBINATION PLIERS	EA	17.74		
MD-R02061	SNIPE NOSED PLIERS DOUBLE PACK	EA	15.40		
MD-R02062	PAIR OF CUTTERS	EA	19.83		
MD-R02063	COMBINATION SPANNER SET	EA	70.54		
MD-R02064	8 BIT RATCHET HIGH QUALITY BAHCO SCREWDRIVER SET	EA	27.18		
MD-R02065	MOLE GRIPS 10" STRAIGHT JAW	EA	12.63		
MD-R02067	STUBBY SCREW DRIVER SET 6 PCE	EA	11.23		
MD-R02068	DREMEL 3000 CORDED PLUS TOOL KIT	EA	70.20		
MD-R02068A	DREMEL 150 PCE ASSORTED TOOLS	EA	45.57		
MD-R02069	UTILITY KNIFE STANLEY FATMAX	EA	15.35		
MD-R02070	STANLEY TRIMMING KNIFE BLADES 5-PACK	PCK	1.12		
MD-R02071	HAMMER SHAFT	EA	5.28		

L2 STORES CATALOGUE

MISCELLANEOUS ITEMS - R





MD-R02072	8 METRE RULE	EA	11.17		
MD-R02073	COPPER/HIDE MALLET 1.5lb	EA	16.70		
MD-R02074	COPPER/RAWHIDE MALLET No.2 (THOR) 2.5lb	EA	29.88		
MD-R02075	COPPER MALLET SIZE 3	EA	24.95		
MD-R02077	150mm DUAL ACTION QUICK CLAMP	EA	13.48		
MD-R02078	300mm DUAL ACTION CLAMP	EA	17.23		
MD-R02079	450mm DUAL ACTION CLAMP STANLEY	EA	35.54		
MD-R02080	150mm RULE STUDENT	EA	5.37		
MD-R02081	300mm RULE STUDENT	EA	12.00		

MH-R03 PINS (various)

MH-R03001	ASSORTED TAPER PINS	EA	0.08		
MH-R03002	ASSORTED CLEVIS PINS	EA	0.34		

L2 STORES CATALOGUE

MISCELLANEOUS ITEMS - R

MH-R03003	ASSORTED TENSION PINS	EA	0.24	
MH-R03004	ASSORTED SPLIT PINS	EA	0.17	
MH-R03005	ASSORTED R CLIPS	EA	0.42	
MH-R03007	ASSTD P CLIP LARGE	EA	2.05	

MH-R04 COMPRESSION SPRINGS



Please visit <http://www.entexstocksprings.co.uk/> for technical information on springs

MH-R04001	1 COMPRESSION SPRING	EA	0.34	
MH-R04003	3 COMPRESSION SPRING	EA	0.70	
MH-R04004	4 COMPRESSION SPRING	EA	0.14	
MH-R04005	5 COMPRESSION SPRING	EA	0.94	
MH-R04008	8 COMPRESSION SPRING	EA	0.70	
MH-R04013	13 COMPRESSION SPRING	EA	0.77	



L2 STORES CATALOGUE

MISCELLANEOUS ITEMS - R

MH-R04015	15 COMPRESSION SPRING	EA	0.77		
MH-R04017	17 COMPRESSION SPRING	EA	0.77		
MH-R04020	20 COMPRESSION SPRING	EA	0.44		

<u>Code</u>	<u>Product</u>	<u>Unit</u>	<u>Std. cost</u>		
MH-R04022	22 COMPRESSION SPRING	EA	1.02		
MH-R04024	24 COMPRESSION SPRING	EA	0.61		
MH-R04026	26 COMPRESSION SPRING	EA	1.33		
MH-R04027	27 COMPRESSION SPRING	EA	0.82		
MH-R04031	31 COMPRESSION SPRING	EA	1.02		
MH-R04036	36 COMPRESSION SPRING	EA	1.33		
MH-R04038	38 COMPRESSION SPRING	EA	1.25		
MH-R04040	40 COMPRESSION SPRING	EA	0.24		
MH-R04042	42 COMPRESSION SPRING	EA	0.25		



L2 STORES CATALOGUE



MISCELLANEOUS ITEMS - R

MH-R04044	44 COMPRESSION SPRING	EA	0.25		
MH-R04045	45 COMPRESSION SPRING	EA	0.89		
MH-R04049	49 COMPRESSION SPRING	EA	0.27		
MH-R04053	53 COMPRESSION SPRING	EA	1.47		
MH-R04054	54 COMPRESSION SPRING	EA	1.47		
MH-R04058	58 COMPRESSION SPRING	EA	1.54		
MH-R04060	60 COMPRESSION SPRING	EA	0.32		
MH-R04061	61 COMPRESSION SPRING	EA	1.75		
MH-R04062	62 COMPRESSION SPRING	EA	0.34		
MH-R04063	63 COMPRESSION SPRING	EA	0.12		
MH-R04067	67 COMPRESSION SPRING	EA	1.21		
MH-R04071	71 COMPRESSION SPRING	EA	1.51		

L2 STORES CATALOGUE



MISCELLANEOUS ITEMS - R

MH-R04072	72 COMPRESSION SPRING	EA	1.54		
MH-R04076	76 COMPRESSION SPRING	EA	1.75		
MH-R04081	81 COMPRESSION SPRING	EA	0.34		
MH-R04082	80 COMPRESSION SPRING	EA	0.34		
MH-R04087	87 COMPRESSION SPRING	EA	1.81		
MH-R04091	91 COMPRESSION SPRING	EA	1.56		
MH-R04092	ASSORTED COMP SPRINGS	EA	0.25		
MH-R04095	95 COMPRESSION SPRING	EA	0.32		
MH-R04096	96 COMPRESSION SPRING	EA	1.68		
MH-R04097	97 COMPRESSION SPRING	EA	1.68		
MH-R04100	100 COMPRESSION SPRING	EA	2.36		
MH-R04102	102 COMPRESSION SPRING	EA	0.32		

MH-R04104	104 COMPRESSION SPRING	EA	0.32		
MH-R04717	192 COMPRESSION SPRING	EA	3.62		
MH-R04719	719 COMPRESSION SPRING	EA	0.37		

MH-R05 TENSION SPRINGS

Please visit <http://www.entexstocksprings.co.uk/> for technical information on springs

MH-R05501	501 TENSION SPRING	EA	0.99		
MH-R05504	504 TENSION SPRING	EA	0.77		

<u>Code</u>	<u>Product</u>	<u>Unit</u>	<u>Std. cost</u>		
MH-R05505	505 TENSION SPRING	EA	0.14		
MH-R05508	508 TENSION SPRING	EA	0.92		
MH-R05509	509 TENSION SPRING	EA	1.04		
MH-R05511	511 TENSION SPRING	EA	1.02		
MH-R05514	514 TENSION SPRING	EA	0.49		
MH-R05516	516 TENSION SPRING	EA	0.49		

L2 STORES CATALOGUE

MISCELLANEOUS ITEMS - R

MH-R05517	517 TENSION SPRING	EA	0.92		
MH-R05519	519 TENSION SPRING	EA	0.92		
MH-R05521	521 TENSION SPRING [OBSOLETE]	EA	0.49		
MH-R05523	523 TENSION SPRING	EA	0.72		
MH-R05525	525 TENSION SPRING	EA	1.13		
MH-R05527	527 TENSION SPRING	EA	1.13		
MH-R05531	531 TENSION SPRING	EA	1.21		
MH-R05533	533 TENSION SPRING	EA	1.49		
MH-R05535	535 TENSION SPRING	EA	1.26		
MH-R05536	536 TENSION SPRING	EA	0.85		
MH-R05539	539 TENSION SPRING	EA	0.24		
MH-R05540	540 TENSION SPRING	EA	1.51		

L2 STORES CATALOGUE

MISCELLANEOUS ITEMS - R

MH-R05543	543 TENSION SPRING	EA	0.25		
MH-R05544	544 TENSION SPRING	EA	0.27		
MH-R05546	546 TENSION SPRING	EA	1.09		
MH-R05550	550 TENSION SPRING	EA	0.27		
MH-R05554	554 TENSION SPRING	EA	1.35		
MH-R05555	555 TENSION SPRING	EA	1.45		
MH-R05558	558 TENSION SPRING	EA	1.37		
MH-R05559	559 TENSION SPRING	EA	0.72		
MH-R05561	561 TENSION SPRING	EA	2.35		
MH-R05563	563 TENSION SPRING	EA	0.32		
MH-R05600	TENSION SPRING VARIOUS	EA	0.17		
MH-R05700	TENSION SPRING MEDIUM	EA	0.85		



L2 STORES CATALOGUE



MISCELLANEOUS ITEMS - R

MH-R05800	TENSION SPRING LARGE	EA	1.71		
-----------	----------------------	----	------	---	--

MH-R07 CLIPS (various)

MH-R07001	ASSORTED CIRCLIPS	EA	0.10		
-----------	-------------------	----	------	---	--

MH-R08 O RINGS & O RING CORD

MH-R08001	O RINGS SMALL < 25mm	EA	0.24		
MH-R08002	O RINGS LARGE > 25mm	EA	0.42		













L2 STORES CATALOGUE

DRILLS SLOT DRILLS - S

Code **Product** **Unit** **Std. cost**













S **DRILLS & SLOT DRILLS**

MH-S01 **TWIST DRILLS - METRIC**

MH-S01001	1.0mm TWIST DRILL LONG SERIES	EA	2.31		
MH-S01021	1.0mm TWIST DRILL DORMER	EA	1.30		
MH-S01022	1.1mm TWIST DRILL DORMER	EA	0.74		
MH-S01023	1.2mm TWIST DORMER	EA	1.71		
MH-S01023A	1.3mm TWIST DRILL DORMER	EA	2.06		
MH-S01024	1.5mm TWIST DRILL DORMER	EA	1.32		
MH-S01025	1.6mm TWIST DRILL DORMER	EA	1.24		
MH-S01026	1.7mm TWIST DRILL DORMER	EA	1.91		
MH-S01026A	1.8mm TWIST DRILL DORMER	EA	1.38		
MH-S01027	2.0mm TWIST DRILL DORMER	EA	1.05		













L2 STORES CATALOGUE

DRILLS SLOT DRILLS - S

MH-S01028	2.1mm TWIST DRILL DORMER	EA	1.63		
MH-S01030	2.5mm TWIST DRILL DORMER	EA	1.27		
MH-S01033	3.0mm TWIST DRILL DORMER	EA	1.81		
MH-S01036	3.3mm TWIST DRILL DORMER	EA	1.38		
MH-S01039	3.5mm TWIST DRILL DORMER	EA	1.47		
MH-S01042	4.0mm TWIST DRILL DORMER	EA	1.53		
MH-S01045	4.2mm TWIST DRILL DORMER	EA	1.47		
MH-S01048	4.5mm TWIST DRILL DORMER	EA	1.80		
MH-S01052	5.0mm TWIST DRILL DORMER	EA	1.89		
MH-S01053	5.0mm TWIST DRILL TAPER SHANK (RUNNING DOWN)	EA	4.80		
MH-S01055	5.1mm TWIST DRILL DORMER	EA	2.48		

L2 STORES CATALOGUE





DRILLS SLOT DRILLS - S

MH-S01058	5.5mm TWIST DRILL DORMER	EA	2.11		
MH-S01061	6.0mm TWIST DRILL DORMER	EA	2.08		
MH-S01064	6.1mm TWIST DRILL DORMER	EA	2.59		
MH-S01067	6.5mm TWIST DRILL DORMER	EA	2.02		
MH-S01070	6.8mm TWIST DRILL DORMER	EA	3.03		
MH-S01073	7.0mm TWIST DRILL DORMER	EA	0.94		
MH-S01077	7.5mm TWIST DRILL DORMER	EA	3.90		
MH-S01080	8.0mm TWIST DRILL DORMER	EA	3.90		
MH-S01081	8.2mm TWIST DRILL DORMER	EA	6.13		
MH-S01086	8.5mm TWIST DRILL DORMER	EA	3.94		
MH-S01090	9.0mm TWIST DRILL DORMER	EA	4.60		

L2 STORES CATALOGUE



DRILLS SLOT DRILLS - S

MH-S01093	9.5mm TWIST DRILL DORMER	EA	3.35		
MH-S01096	10.0mm TWIST DRILL DORMER	EA	5.85		
MH-S01100	10.2mm TWIST DRILL DORMER	EA	6.95		
MH-S01103	10.5mm TWIST DRILL DORMER	EA	6.95		
MH-S01106	10.6mm TWIST DRILL DORMER	EA	11.37		
MH-S01110	11.0mm TWIST DRILL DORMER	EA	10.13		
MH-S01113	11.5mm TWIST DRILL DORMER	EA	6.85		
MH-S01116	12.0mm TWIST DRILL DORMER	EA	8.54		









<u>Code</u>	<u>Product</u>	<u>Unit</u>	<u>Std. cost</u>		
MH-S01120	12.2mm TWIST DRILL DORMER	EA	23.18		
MH-S01123	12.5mm TWIST DRILL DORMER	EA	18.73		
MH-S01126	13.0mm TWIST DRILL DORMER	EA	20.98		

L2 STORES CATALOGUE

DRILLS SLOT DRILLS - S













MH-S01130	14.0mm TWIST DRILL DORMER	EA	20.19		
MH-S01133	16.0mm TWIST DRILL DORMER	EA	19.69		

MH-S02 TWIST DRILLS - IMPERIAL

MH-S02001	1/64" TWIST DRILL	EA	2.02		
MH-S02003	1/32" TWIST DRILL	EA	1.23		
MH-S02005	1/16" TWIST DRILL	EA	1.13		
MH-S02007	5/64" TWIST DRILL	EA	0.85		
MH-S02009	3/32" TWIST DRILL	EA	1.11		
MH-S02011	7/64" TWIST DRILL	EA	0.78		
MH-S02013	1/8" TWIST DRILL	EA	1.11		
MH-S02015	9/64" TWIST DRILL	EA	1.26		













L2 STORES CATALOGUE

DRILLS SLOT DRILLS - S

MH-S02017	5/32" TWIST DRILL	EA	1.69		
MH-S02019	11/64" TWIST DRILL	EA	1.88		
MH-S02021	3/16" TWIST DRILL	EA	1.61		
MH-S02023	13/64" TWIST DRILL	EA	11.29		
MH-S02025	7/32" TWIST DRILL (RUNNING DOWN)	EA	1.99		
MH-S02027	15/64" TWIST DRILL	EA	1.76		
MH-S02029	1/4" TWIST DRILL	EA	1.54		
MH-S02031	17/64" TWIST DRILL	EA	4.20		
MH-S02033	9/32" TWIST DRILL	EA	4.18		
MH-S02035	19/64" TWIST DRILL	EA	4.42		
MH-S02037	5/16" TWIST DRILL	EA	3.84		

L2 STORES CATALOGUE

DRILLS SLOT DRILLS - S

MH-S02039	21/64" TWIST DRILL	EA	7.09		
MH-S02041	11/32" TWIST DRILL	EA	2.83		
MH-S02043	23/64" TWIST DRILL	EA	6.82		
MH-S02045	3/8" TWIST DRILL	EA	6.70		
MH-S02047	25/64" TWIST DRILL	EA	4.82		
MH-S02051	27/64" TWIST DRILL	EA	5.55		
MH-S02053	7/16" TWIST DRILL	EA	4.87		
MH-S02055	29/64" TWIST DRILL	EA	6.81		
MH-S02057	15/32" TWIST DRILL	EA	5.69		
MH-S02059	31/64" TWIST DRILL	EA	7.82		
MH-S02061	1/2" TWIST DRILL	EA	10.43		



L2 STORES CATALOGUE

DRILLS SLOT DRILLS - S

MH-S02065	3/4" TWIST DRILL	EA	62.08		
-----------	------------------	----	-------	---	--













MH-S03 TWIST DRILLS LONG REACH - IMPERIAL (RUNNING DOWN)

MH-S03001	3/64" TWIST DRILL LONG REACH	EA	4.85		
-----------	------------------------------	----	------	---	--

<u>Code</u>	<u>Product</u>	<u>Unit</u>	<u>Std. cost</u>		
MH-S03003	1/16" TWIST DRILL LONG REACH	EA	1.85		
MH-S03005	3/32" TWIST DRILL LONG REACH	EA	1.78		
MH-S03007	7/64" TWIST DRILL LONG REACH	EA	1.25		
MH-S03009	1/8" TWIST DRILL LONG REACH	EA	1.88		
MH-S03011	9/64" TWIST DRILL LONG REACH	EA	4.73		
MH-S03013	5/32" TWIST DRILL LONG REACH	EA	2.16		
MH-S03015	11/64" TWIST DRILL LONG REACH	EA	3.63		
MH-S03017	3/16" TWIST DRILL LONG REACH	EA	2.65		







L2 STORES CATALOGUE

DRILLS SLOT DRILLS - S





MH-S03019	13/64" TWIST DRILL LONG REACH	EA	4.85		
MH-S03021	7/32" TWIST DRILL LONG REACH	EA	4.10		
MH-S03023	15/64" TWIST DRILL LONG REACH	EA	4.25		
MH-S03025	1/4" TWIST DRILL LONG REACH	EA	3.96		
MH-S03027	9/32" TWIST DRILL LONG REACH	EA	1.78		
MH-S03029	19/64" TWIST DRILL LONG REACH	EA	2.02		
MH-S03031	5/16" TWIST DRILL LONG REACH	EA	5.95		
MH-S03033	21/64" TWIST DRILL LONG REACH	EA	11.32		
MH-S03035	23/64" TWIST DRILL LONG REACH	EA	10.12		
MH-S03037	3/8" TWIST DRILL LONG REACH	EA	8.73		
MH-S03039	25/64" TWIST DRILL LONG REACH	EA	16.76		

L2 STORES CATALOGUE

DRILLS SLOT DRILLS - S











MH-S03041	13/32" TWIST DRILL LONG REACH	EA	10.39		
MH-S03045	7/16" TWIST DRILL LONG REACH	EA	12.42		
MH-S03047	29/64" TWIST DRILL LONG REACH	EA	22.41		
MH-S03049	15/32" TWIST DRILL LONG REACH	EA	22.87		
MH-S03051	31/64" TWIST DRILL LONG REACH	EA	19.37		
MH-S03053	1/2" TWIST DRILL LONG REACH	EA	17.19		

MD-S04 NUMBER TWIST DRILLS

MD-S04001	NUMBER 1 TWIST DRILL	EA	2.53		
MD-S04002	NUMBER 2 TWIST DRILL	EA	2.40		
MD-S04003	NUMBER 3 TWIST DRILL	EA	2.28		
MD-S04004	NUMBER 4 TWIST DRILL	EA	2.21		

L2 STORES CATALOGUE

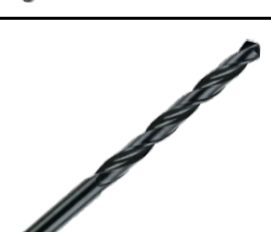
DRILLS SLOT DRILLS - S

MD-S04005	NUMBER 5 TWIST DRILL	EA	2.17		
MD-S04006	NUMBER 6 TWIST DRILL	EA	2.12		
MD-S04007	NUMBER 7 TWIST DRILL	EA	2.09		
MD-S04008	NUMBER 8 TWIST DRILL	EA	2.07		
MD-S04009	NUMBER 9 TWIST DRILL	EA	2.02		
MD-S04010	NUMBER 10 TWIST DRILL	EA	1.80		
MD-S04011	NUMBER 11 TWIST DRILL	EA	1.85		
MD-S04012	NUMBER 12 TWIST DRILL	EA	1.23		
MD-S04013	NUMBER 13 TWIST DRILL	EA	1.23		
MD-S04014	NUMBER 14 TWIST DRILL	EA	1.85		

Code











Product

Unit

Std. cost

L2 STORES CATALOGUE









DRILLS SLOT DRILLS - S

MD-S04015	NUMBER 15 TWIST DRILL	EA	1.81		
MD-S04016	NUMBER 16 TWIST DRILL	EA	0.96		
MD-S04017	NUMBER 17 TWIST DRILL	EA	1.71		
MD-S04018	NUMBER 18 TWIST DRILL	EA	1.19		
MD-S04019	NUMBER 19 TWIST DRILL	EA	1.64		
MD-S04020	NUMBER 20 TWIST DRILL	EA	1.61		
MD-S04021	NUMBER 21 TWIST DRILL	EA	1.61		
MD-S04022	NUMBER 22 TWIST DRILL	EA	1.61		
MD-S04023	NUMBER 23 TWIST DRILL	EA	1.54		
MD-S04024	NUMBER 24 TWIST DRILL	EA	1.54		
MD-S04025	NUMBER 25 TWIST DRILL	EA	0.97		



L2 STORES CATALOGUE



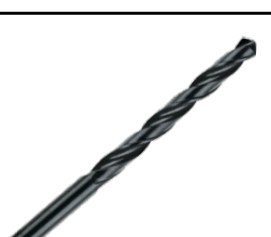
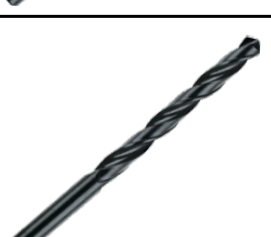









DRILLS SLOT DRILLS - S

MD-S04026	NUMBER 26 TWIST DRILL	EA	1.51		
MD-S04027	NUMBER 27 TWIST DRILL	EA	1.47		
MD-S04028	NUMBER 28 TWIST DRILL	EA	0.90		
MD-S04029	NUMBER 29 TWIST DRILL	EA	1.40		
MD-S04030	NUMBER 30 TWIST DRILL	EA	1.24		
MD-S04031	NUMBER 31 TWIST DRILL	EA	1.32		
MD-S04032	NUMBER 32 TWIST DRILL	EA	1.28		
MD-S04033	NUMBER 33 TWIST DRILL	EA	1.28		
MD-S04034	NUMBER 34 TWIST DRILL	EA	1.26		
MD-S04035	NUMBER 35 TWIST DRILL	EA	1.28		
MD-S04036	NUMBER 36 TWIST DRILL	EA	2.65		











L2 STORES CATALOGUE



DRILLS SLOT DRILLS - S



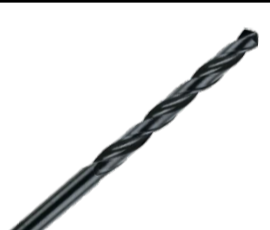







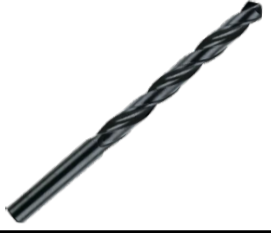

MD-S04037	NUMBER 37 TWIST DRILL	EA	1.25		
MD-S04038	NUMBER 38 TWIST DRILL	EA	1.25		
MD-S04039	NUMBER 39 TWIST DRILL	EA	1.20		
MD-S04040	NUMBER 40 TWIST DRILL	EA	1.25		
MD-S04041	NUMBER 41 TWIST DRILL	EA	1.25		
MD-S04042	NUMBER 42 TWIST DRILL	EA	1.25		
MD-S04043	NUMBER 43 TWIST DRILL	EA	1.26		
MD-S04044	NUMBER 44 TWIST DRILL	EA	1.25		
MD-S04045	NUMBER 45 TWIST DRILL	EA	1.26		
MD-S04046	NUMBER 46 TWIST DRILL	EA	1.26		
MD-S04047	NUMBER 47 TWIST DRILL	EA	1.28		

L2 STORES CATALOGUE

DRILLS SLOT DRILLS - S













MD-S04048	NUMBER 48 TWIST DRILL	EA	1.28		
MD-S04049	NUMBER 49 TWIST DRILL	EA	1.28		
MD-S04050	NUMBER 50 TWIST DRILL	EA	1.32		
MD-S04051	NUMBER 51 TWIST DRILL	EA	0.87		
MD-S04052	NUMBER 52 TWIST DRILL	EA	1.37		
MD-S04053	NUMBER 53 TWIST DRILL	EA	2.68		
MD-S04054	NUMBER 54 TWIST DRILL	EA	0.96		
MD-S04055	NUMBER 55 TWIST DRILL	EA	1.57		
MD-S04056	NUMBER 56 TWIST DRILL	EA	1.64		

<u>Code</u>	<u>Product</u>	<u>Unit</u>	<u>Std. cost</u>		
MD-S04057	NUMBER 57 TWIST DRILL	EA	1.75		
MD-S04058	NUMBER 58 TWIST DRILL	EA	1.80		

MD-S04059	NUMBER 59 TWIST DRILL	EA	1.81		
MD-S04060	NUMBER 60 TWIST DRILL	EA	1.87		
MD-S04061	NUMBER 61 TWIST DRILL	EA	1.88		
MD-S04062	NUMBER 62 TWIST DRILL	EA	1.92		
MD-S04063	NUMBER 63 TWIST DRILL	EA	1.93		
MD-S04064	NUMBER 64 TWIST DRILL	EA	1.99		
MD-S04065	NUMBER 65 TWIST DRILL	EA	2.02		
MD-S04066	NUMBER 66 TWIST DRILL	EA	2.11		
MD-S04067	NUMBER 67 TWIST DRILL	EA	2.14		
MD-S04068	NUMBER 68 TWIST DRILL	EA	1.23		
MD-S04069	NUMBER 69 TWIST DRILL	EA	2.28		

L2 STORES CATALOGUE

DRILLS SLOT DRILLS - S













MD-S04070	NUMBER 70 TWIST DRILL	EA	2.31		
MD-S04071	NUMBER 71 TWIST DRILL	EA	2.41		
MD-S04072	NUMBER 72 TWIST DRILL	EA	2.47		
MD-S04073	NUMBER 73 TWIST DRILL	EA	2.55		
MD-S04074	NUMBER 74 TWIST DRILL	EA	2.57		
MD-S04075	NUMBER 75 TWIST DRILL	EA	2.65		
MD-S04076	NUMBER 76 TWIST DRILL	EA	4.73		
MD-S04077	NUMBER 77 TWIST DRILL	EA	4.85		
MD-S04078	NUMBER 78 TWIST DRILL	EA	2.96		
MD-S04079	NUMBER 79 TWIST DRILL	EA	3.12		
MD-S04080	NUMBER 80 TWIST DRILL	EA	6.45		

L2 STORES CATALOGUE

DRILLS SLOT DRILLS - S





MF-S05







LETTER TWIST DRILLS

MF-S05001	LETTER A DRILL	EA	3.36		
MF-S05002	LETTER B DRILL	EA	3.46		
MF-S05003	LETTER C DRILL	EA	8.17		
MF-S05004	LETTER D DRILL	EA	2.90		
MF-S05005	LETTER E DRILL	EA	3.80		
MF-S05006	LETTER F DRILL	EA	4.06		
MF-S05007	LETTER G DRILL	EA	4.16		
MF-S05008	LETTER H DRILL	EA	8.28		
MF-S05009	LETTER I DRILL	EA	3.36		
MF-S05010	LETTER J DRILL	EA	4.71		
MF-S05011	LETTER K DRILL	EA	1.93		

L2 STORES CATALOGUE

DRILLS SLOT DRILLS - S





MF-S05012	LETTER L DRILL	EA	5.14		
MF-S05013	LETTER M DRILL	EA	5.28		
MF-S05014	LETTER N DRILL	EA	5.42		
MF-S05015	LETTER O DRILL	EA	6.10		
MF-S05016	LETTER P DRILL	EA	3.02		

<u>Code</u>	<u>Product</u>	<u>Unit</u>	<u>Std. cost</u>		
MF-S05017	LETTER Q DRILL	EA	6.81		
MF-S05018	LETTER R DRILL	EA	4.93		
MF-S05019	LETTER S DRILL	EA	7.32		
MF-S05020	LETTER T DRILL	EA	7.82		
MF-S05021	LETTER U DRILL	EA	8.39		
MF-S05022	LETTER V DRILL	EA	8.71		



L2 STORES CATALOGUE

DRILLS SLOT DRILLS - S

MF-S05023	LETTER W DRILL	EA	4.41		
MF-S05024	LETTER X DRILL	EA	9.72		
MF-S05025	LETTER Y DRILL	EA	10.14		
MF-S05026	LETTER Z DRILL	EA	8.85		











MF-S07 CENTRE DRILLS

MF-S07001	1 BS CENTRE DRILL (RH CUTTING)	EA	1.14		
MF-S07002	2 BS CENTRE DRILL (RH CUTTING)	EA	2.20		
MF-S07003	3 BS CENTRE DRILL (RH CUTTING)	EA	2.62		
MF-S07004	4 BS CENTRE DRILL (RH CUTTING)	EA	4.02		
MF-S07005	5 BS CENTRE DRILL (RH CUTTING)	EA	6.94		
MF-S07006	7 BS CENTRE DRILL (RH CUTTING) DORMER	EA	28.36		

MF-S08 MASONRY & SDS DRILLS

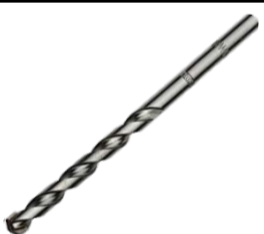
L2 STORES CATALOGUE

DRILLS SLOT DRILLS - S

MF-S08001	6 MASONRY DRILL (4mm/5/32")	EA	1.33		
MF-S08003	8 MASONRY DRILL (5mm/3/16")	EA	1.50		
MF-S08005	10 MASONRY DRILL (5.5mm/7/32")	EA	1.96		
MF-S08007	11 MASONRY DRILL(6mm/15/64")	EA	2.50		
MF-S08009	12 MASONRY DRILL (6.5mm/1/4")	EA	1.32		
MF-S08011	14 MASONRY DRILL (7.0mm/9/32")	EA	1.52		
MF-S08013	16 MASONRY DRILL (8mm/5/16")	EA	2.04		
MF-S08015	20 MASONRY DRILL (10mm/25/64")	EA	2.81		
MF-S08017	24 MASONRY DRILL (13mm/1/2")	EA	2.95		
MF-S08020	BOSCH SDS DRILL BIT 5 x 160mm	EA	4.00		
MF-S08022	BOSCH SDS DRILL BIT 6 x 160mm	EA	4.72		



L2 STORES CATALOGUE

DRILLS SLOT DRILLS - S

MF-S08024	SDS DRILL BIT 7.0mm	EA	4.30		
MF-S08026	BOSCH SDS DRILLBIT 8 x 160mm	EA	5.11		
MF-S08028	BOSCH SDS DRILL BIT 10 x 160mm	EA	3.15		
MF-S08030	BOSCH SDS DRILL BIT 12 x 210mm	EA	4.28		
MF-S08031	13.0mm SDS DRILL BIT	EA	8.71		
MF-S08032	MASONRY DRILL SET STD/LS (8 PCE)	EA	23.69		



MF-S10

SLOT DRILLS - METRIC

MF-S10000	1.0mm THROWAWAY CUTTER	EA	11.24		
MF-S10002	1.5mm THROWAWAY CUTTER	EA	9.50		
MF-S10003	1.5mm SLOT DRILL STANDARD	EA	35.06		
MF-S10004	2.0mm THROWAWAY CUTTER	EA	9.89		

L2 STORES CATALOGUE

DRILLS SLOT DRILLS - S

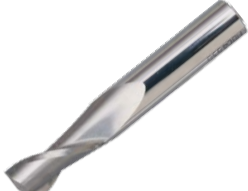
MF-S10005	2.0mm SLOT DRILL STANDARD	EA	19.15		
MF-S10006	2.0mm BALL NOSE SLOT DRILL STD	EA	23.14		
MF-S10007	2.5mm SLOT DRILL STANDARD	EA	10.04		

<u>Code</u>	<u>Product</u>	<u>Unit</u>			
MF-S10008	3.0mm THROWAWAY CUTTER	EA	10.16		
MF-S10009	3.0mm SLOT DRILL STANDARD	EA	18.10		
MF-S10010	3.0mm BALL NOSE SLOT DRILL STD	EA	20.05		
MF-S10011	3.5mm SLOT DRILL STANDARD	EA	13.10		
MF-S10012	4.0mm THROWAWAY CUTTER	EA	9.43		
MF-S10013	4.0mm SLOT DRILL STANDARD	EA	20.18		
MF-S10014	4.0mm BALL NOSE SLOT DRILL STD	EA	20.05		
MF-S10015	5.0mm SLOT DRILL STANDARD	EA	25.40		

L2 STORES CATALOGUE













DRILLS SLOT DRILLS - S

MF-S10016	5.0mm BALL NOSED SLT DRILL STD	EA	20.50		
MF-S10016A	5.0mm THROWAWAY CUTTER	EA	9.20		
MF-S10016B	5.0mm L/S THROWAWAY CUTTER	EA	10.36		
MF-S10017	5.5mm SLOT DRILL STANDARD	EA	26.28		
MF-S10019	6.0mm SLOT DRILL STANDARD	EA	16.38		
MF-S10020	6.0mm BALL NOSED SLOT DRILL STD	EA	20.82		
MF-S10020A	6.0mm THROWAWAY CUTTER	EA	9.30		
MF-S10021	6.5mm SLOT DRILL STANDARD	EA	31.72		
MF-S10023	7.0mm SLOT DRILL STANDARD	EA	11.16		
MF-S10027	8.0mm SLOT DRILL STANDARD	EA	25.18		



L2 STORES CATALOGUE





DRILLS SLOT DRILLS - S

MF-S10027A	8.0mm THROWAWAY CUTTER	EA	14.61		
MF-S10027B	8.0mm L/S THROWAWAY CUTTER	EA	14.74		
MF-S10029	8.5mm SLOT DRILL STANDARD	EA	13.00		
MF-S10031	9.0mm SLOT DRILL STANDARD	EA	13.55		
MF-S10035	10.0mm SLOT DRILL STANDARD	EA	10.74		
MF-S10036	10.0mm BALL NOSED SLOT DRILL STD	EA	30.00		
MF-S10036A	10.0mm THROWAWAY CUTTER	EA	14.61		
MF-S10039	11.0mm SLOT DRILL STANDARD	EA	16.69		
MF-S10041	12.0mm SLOT DRILL STANDARD	EA	66.13		
MF-S10043	13.0mm SLOT DRILL STANDARD	EA	21.20		
MF-S10045	14.0mm SLOT DRILL STANDARD	EA	44.06		

L2 STORES CATALOGUE





DRILLS SLOT DRILLS - S

MF-S10047	15.0mm SLOT DRILL STANDARD	EA	68.60		
MF-S10049	16.0mm SLOT DRILL STANDARD	EA	16.35		
MF-S10051	18.0mm SLOT DRILL STANDARD	EA	88.99		
MF-S10053	20.0mm SLOT DRILL STANDARD	EA	70.00		
MF-S10055	22.0mm SLOT DRILL STANDARD	EA	36.53		
MF-S10070	2.0mm SLOT DRILL LONG SERIES	EA	13.03		
MF-S10074	5.0mm SLOT DRILL LONG SERIES	EA	28.31		

<u>Code</u>	<u>Product</u>	<u>Unit</u>	<u>Std. cost</u>		
MF-S10076	6.0mm SLOT DRILL LONG SERIES	EA	28.31		
MF-S10078	8.0mm SLOT DRILL LONG SERIES	EA	29.23		
MF-S10080	10.0mm SLOT DRILL LONG SERIES	EA	33.83		

L2 STORES CATALOGUE

DRILLS SLOT DRILLS - S

MF-S10082	12.0mm SLOT DRILL LONG SERIES	EA	42.60		
MF-S10086	16.0mm SLOT DRILL LONG SERIES	EA	61.38		
MF-S10088	20.0mm SLOT DRILL LONG SERIES	EA	80.10		
MF-S10090	25.0mm SLOT DRILL LONG SERIES	EA	135.50		

MF-S11 END MILLS / AL KARB

<u>Code</u>	<u>Product</u>	<u>Unit</u>	<u>Std. cost</u>		
MF-S11090	3.0mm CARBIDE AL-KARB MILL CUTTER	EA	19.21		
MF-S11091	4.0mm CARBIDE AL-KARB MILL CUTTERS	EA	18.45		
MF-S11092	5.0mm CARBIDE AL-KARB MILLING CUTTER	EA	22.55		
MF-S11093	6.0mm CARBIDE AL-KARB MILL CUTTER	EA	23.49		
MF-S11094	8.0mm CARBIDE AL-KARB MILL CUTTER	EA	28.85		
MF-S11095	10.0mm CARBIDE AL-KARB MILL CUTTER	EA	30.75		



L2 STORES CATALOGUE

DRILLS SLOT DRILLS - S

MF-S11096	12.0mm CARBIDE AL-KARB MILL CUTTER	EA	52.27		
MF-S11097	6.0mm HIGH HELIX CARBIDE END MILL	EA	21.76		
MF-S11098	8.0mm HIGH HELIX END MILL	EA	32.97		
MF-S11099	10.0mm HIGH HELIX END	EA	45.00		
MF-S11100	12.0mm HIGH HELIX END MILL	EA	49.87		

MF-S12 END MILLS / LONG SERIES END MILLS - METRIC

MF-S12002	2.5 mm END MILL STANDARD	EA	13.74		
MF-S12004	3.0 mm END MILL STANDARD	EA	23.72		
MF-S12006	3.5 mm END MILL STANDARD	EA	9.86		
MF-S12008	4.0 mm END MILL STANDARD	EA	10.31		
MF-S12010	4.5 mm END MILL STANDARD	EA	9.86		

L2 STORES CATALOGUE

DRILLS SLOT DRILLS - S

MF-S12012	5.0 mm END MILL STANDARD	EA	10.48		
MF-S12014	5.5 mm END MILL STANDARD	EA	17.04		
MF-S12016	6.0 mm END MILL STANDARD	EA	9.42		
MF-S12018	6.5 mm END MILL STANDARD	EA	19.67		
MF-S12020	7.0 mm END MILL STANDARD	EA	12.16		
MF-S12022	8.0 mm END MILL STANDARD	EA	27.28		
MF-S12024	8.5 mm END MILL STANDARD	EA	13.55		
MF-S12026	9.0 mm END MILL STANDARD	EA	16.39		
MF-S12030	10.0mm END MILL STANDARD	EA	36.36		
MF-S12038	12.0mm END MILL STANDARD	EA	30.52		
MF-S12040	13.0mm END MILL STANDARD	EA	17.04		

L2 STORES CATALOGUE

DRILLS SLOT DRILLS - S

MF-S12042	14.0mm END MILL STANDARD	EA	17.04		
MF-S12044	15.0mm END MILL STANDARD	EA	20.99		
MF-S12046	16.0mm END MILL STANDARD	EA	58.20		
MF-S12050	18.0mm END MILL STANDARD	EA	22.30		
MF-S12052	19.0mm END MILL STANDARD	EA	35.44		
MF-S12054	20.0mm END MILL STANDARD	EA	156.00		



<u>Code</u>	<u>Product</u>	<u>Unit</u>	<u>Std. cost</u>		
MF-S12056	21.0mm END MILL STANDARD	EA	42.18		
MF-S12058	22.0mm END MILL STANDARD	EA	48.15		
MF-S12060	25.0mm END MILL STANDARD (RUNNING DOWN)	EA	27.11		
MF-S12080	5.0mm END MILL LONG SERIES	EA	14.43		
MF-S12082	6.0mm END MILL LONG SERIES	EA	14.43		

L2 STORES CATALOGUE

DRILLS SLOT DRILLS - S

MF-S12086	8.0mm END MILL LONG SERIES	EA	14.88		
MF-S12088	10.0mm END MILL LONG SERIES	EA	61.00		
MF-S12089	12.0mm END MILL LONG SERIES	EA	30.64		
MF-S12094	16.0mm END MILL LONG SERIES	EA	182.30		
MF-S12096	20.0mm END MILL LONG SERIES	EA	60.30		

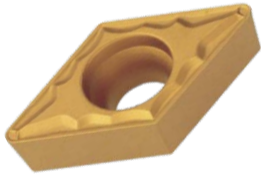
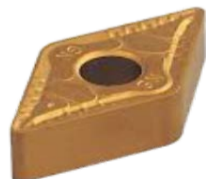
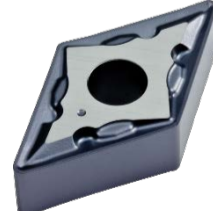
MF-S13 INSERT TIPS/ TOOL HOLDER / TANG GRIP

MF-S13000	TURNING TIP DCMT 11T304F2HX	EA	9.14		
MF-S13001	TURNING TIP DNMG150604-M3TP1000	EA	9.07		
MF-S13002	TURNING TIP DNMG150608 MF3TP200	EA	12.89		
MF-S13003	TURNING TIP CNMG 120408TMT9025	EA	9.01		

L2 STORES CATALOGUE



DRILLS SLOT DRILLS - S

MF-S13004	TURNING TIP CCMT60202F1CP500	EA	7.00		
MF-S13005	TURNING TIP CCMT09T304MF2TP1000	EA	9.96		
MF-S13006	TURNING TIP CNMG120404MF2TP1000	EA	9.41		
MF-S13007	TURNING TIP DCMT11T304PM	EA	6.97		
MF-S13008	TURNING TIP DCMT11T302T9025	EA	8.36		
MF-S13009	PARTING TIP GIP3.30-0.10	EA	14.56		
MF-S13010	PARTING TIP 150.10-3N-16T25M	EA	15.98		
MF-S13011	LNMX110408R-HT IC9025	EA	9.61		
MF-S13014	BORING TIP TPMR160304-23T9025	EA	8.93		
MF-S13015	BORING TIP TPGN160304235	EA	8.92		
MF-S13018	MILLING TIP R390170408PM1025	EA	14.05		

L2 STORES CATALOGUE

DRILLS SLOT DRILLS - S

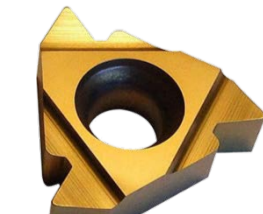
MF-S13025	SCREW CUTTING TIP 22 ER 4.0150CP500	EA	11.33		
MF-S13026	SCREW CUTTING TIP 22NR4.0150CP500	EA	23.90		
MF-S13027	SCREW CUTTING TIP 16IR1.0150IC908	EA	13.97		
MF-S13028	SCREW CUTTING TIP 16ER1.0150CP500	EA	13.96		
MF-S13029	SCREW CUTTING TIP 16ER3.0150CP500	EA	13.96		
MF-S13030	SCREW CUTTING TIP 16ER2.0150CP500	EA	13.96		
MF-S13031	SCREW CUTTING TIP 16IR2.0150CP500	EA	13.96		

<u>Code</u>	<u>Product</u>	<u>Unit</u>			
MF-S13032	SCREW CUTTING TIP 16IR3.0150CP500	EA	13.96		
MF-S13035	SCREW CUTTING TIP 16ER1.25 ISO IC908	EA	13.96		





L2 STORES CATALOGUE

DRILLS SLOT DRILLS - S

MF-S13036	SCREW CUTTING TIP 16IR 1.25 ISO IC908	EA	15.75		
MF-S13037	SCREW CUTTING TIP 16ER 1.5 ISO IC908	EA	13.96		
MF-S13038	SCREW CUTTING TIP 16IR 1.5 ISO IC908	EA	17.38		
MF-S13039	SCREW CUTTING TIP 16ER 2.5 ISO IC908	EA	13.96		
MF-S13040	SCREW CUTTING TIP 16IR 2.50 ISO IC908	EA	17.38		
MF-S13041	SCREW CUTTING TIP 16ER1.75ISO IC908	EA	13.96		
MF-S13042	SCREW CUTTING TIP 16IR 1.75ISO IC908	EA	13.96		
MF-S13045	ALUMINIUM TURNING TIP SDCGX11T304ALH10	EA	12.97		
MF-S13046	ALUMINIUM TURNING TIP CNGP120404	EA	8.22		
MF-S13047	ALUMINIUM TURNING TIP DNMG150604-23H13A	EA	13.42		
					

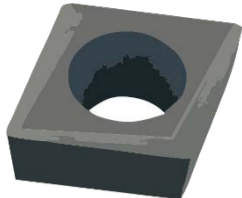
L2 STORES CATALOGUE

DRILLS SLOT DRILLS - S

MF-S13054	INSERT CCGT060202L-W15-NS530	EA	12.22		
MF-S13056	INSERT TAG CN3IC808	EA	11.77		
MF-S13060	DOUBLE ENDED TANG GRIP PARTING BLADE	EA	99.42		
MF-S13061	TGFH HOLDER	EA	30.00		

MF-S14 TOOL BITS

MF-S14001	3/16" x 3/16" x 4" TOOL BIT	EA	2.98		
MF-S14002	1/4" x 1/4" x 4" TOOL BIT	EA	4.26		
MF-S14003	5/16" x 5/16" x 4" TOOL BIT	EA	19.74		
MF-S14004	3/8" x 3/8" x 4" TOOL BIT	EA	7.72		
MF-S14005	1/2" x 1/2" x 4" TOOL BIT	EA	13.39		
MF-S14006	5/8" x 5/8" x 4" TOOL BIT	EA	24.10		



MF-S14007	3/4" x 3/4" x 4" TOOL BIT	EA	33.08		
-----------	---------------------------	----	-------	---	--

MF-S20**SPOTTING DRILLS**

MF-S20003	3.0mm SPOTTING DRILL	EA	13.52		
MF-S20005	4.0mm SPOTTING DRILL	EA	13.81		
MF-S20007	5.0mm SPOTTING DRILL	EA	17.86		
MF-S20009	6.0mm SPOTTING DRILL	EA	18.91		
MF-S20011	8.0mm SPOTTING DRILL	EA	29.65		
MF-S20013	9.0mm SPOTTING DRILL	EA	29.54		
MF-S20015	10.0mm SPOTTING DRILL	EA	27.66		
MF-S20017	12.0mm SPOTTING DRILL	EA	40.97		



L2 STORES CATALOGUE**TOOLS (various) - T****Code** **Product** **Unit** **Std. cost****T** **TOOLS (various)****MH-T01** **TAPS & DIES - METRIC**

MH-T01002	2.0mm TAPER TAP	EA	10.48		
MH-T01003	2.0mm 2ND TAP	EA	10.48		
MH-T01004	2.0mm PLUG TAP	EA	13.83		
MH-T01005	2.5mm TAPER TAP	EA	11.97		
MH-T01006	2.5mm 2ND TAP	EA	11.97		
MH-T01007	2.5mm PLUG TAP	EA	19.52		
MH-T01008	3.0mm TAPER TAP	EA	8.75		
MH-T01009	3.0mm 2ND TAP	EA	6.37		
MH-T01010	3.0mm PLUG TAP	EA	6.55		
MH-T01011	3.5mm TAPER TAP	EA	12.20		
MH-T01013	3.5mm PLUG TAP	EA	13.21		
MH-T01014	4.0mm TAPER TAP	EA	6.00		

L2 STORES CATALOGUE



TOOLS (various) - T

MH-T01015	4.0mm 2ND TAP	EA	6.62		
MH-T01016	4.0mm PLUG TAP	EA	6.00		
MH-T01020	5.0mm TAPER TAP	EA	5.51		
MH-T01021	5.0mm 2ND TAP	EA	3.49		
MH-T01022	5.0mm PLUG TAP	EA	3.49		
MH-T01026	6.0mm TAPER TAP	EA	12.58		
MH-T01027	6.0mm 2ND TAP	EA	3.49		
MH-T01028	6.0mm PLUG TAP	EA	5.49		
MH-T01032	8.0mm TAPER TAP	EA	12.94		
MH-T01033	8.0mm 2ND TAP	EA	12.62		
MH-T01034	8.0mm PLUG TAP	EA	9.94		
MH-T01038	10.0mm TAPER TAP	EA	10.85		

L2 STORES CATALOGUE

TOOLS (various) - T

MH-T01039	10.0mm 2ND TAP	EA	10.53		
MH-T01040	10.0mm PLUG TAP	EA	12.01		
MH-T01044	12.0mm TAPER TAP	EA	9.74		
MH-T01045	12.0mm 2ND TAP	EA	10.86		
MH-T01046	12.0mm PLUG TAP	EA	9.74		
MH-T01053	16.0mm TAPER TAP	EA	16.30		
MH-T01054	16.0mm 2ND TAP	EA	16.30		
MH-T01055	16.0mm PLUG TAP	EA	23.00		
MH-T01070	2.0mm DIE	EA	12.88		
MH-T01071	2.5mm DIE	EA	9.84		

<u>Code</u>	<u>Product</u>	<u>Unit</u>	<u>Std. cost</u>		
MH-T01072	3.0mm DIE	EA	23.56		
MH-T01073	3.5mm DIE	EA	29.60		

L2 STORES CATALOGUE

TOOLS (various) - T













MH-T01074	4.0mm DIE	EA	16.78		
MH-T01075	5.0mm DIE	EA	18.00		
MH-T01077	6.0mm DIE	EA	33.00		
MH-T01079	8.0mm DIE	EA	39.61		
MH-T01081	10.0mm DIE	EA	27.97		
MH-T01083	12.0mm DIE	EA	17.03		
MH-T01086	16.0mm DIE	EA	47.94		
MH-T01089	20.0mm DIE	EA	62.30		

MH-T02 TAPS & DIES BSF

MH-T02002	1/4" BSF TAPER TAP RUNNING DOWN	EA	9.48		
MH-T02004	1/4" BSF PLUG TAP RUNNING DOWN	EA	11.11		
MH-T02009	3/8" BSF 2ND TAP RUNNING DOWN	EA	5.76		
MH-T02010	3/8" BSF PLUG TAP RUNNING DOWN	EA	6.95		





L2 STORES CATALOGUE

TOOLS (various) - T

MH-T02014	1/2" BSF TAPER TAP RUNNING DOWN	EA	11.31		
MH-T02015	1/2" BSF 2ND TAP RUNNING DOWN	EA	11.40		
MH-T02016	1/2" BSF PLUG TAP RUNNING DOWN	EA	11.39		
MH-T02017	3/4" BSF 2ND TAP RUNNING DOWN	EA	14.26		
MH-T02020	7/8" BSF TAPER TAP RUNNING DOWN	EA	21.00		
MH-T02021	7/8" BSF PLUG TAP RUNNING DOWN	EA	24.88		
MH-T02023	1" BSF TAPER TAP RUNNING DOWN	EA	24.88		
MH-T02024	1" BSF 2ND TAP RUNNING DOWN	EA	25.15		
MH-T02025	1" BSF PLUG TAP RUNNING DOWN	EA	25.15		
MH-T02026	1 1/8" BSF TAPER TAP RUNNING DOWN	EA	40.70		
MH-T02027	1 1/8" BSF 2ND TAP RUNNING DOWN	EA	40.70		
MH-T02028	1 1/8" BSF PLUG TAP RUNNING DOWN	EA	40.70		

L2 STORES CATALOGUE

TOOLS (various) - T











MH-T02032	1 1/2" BSF TAPER TAP RUNNING DOWN	EA	68.59		
MH-T02033	1 1/2" BSF 2ND TAP RUNNING DOWN	EA	208.78		
MH-T02050	1/4" DIE BSF RUNNING DOWN	EA	35.01		
MH-T02052	3/8" DIE BSF RUNNING DOWN	EA	18.56		
MH-T02054	1/2" DIE BSF RUNNING DOWN	EA	22.42		

Code **Product** **Unit** **Std. cost**
[MH-T03](#) [BA TAPS & DIES](#)

MH-T03001	OBA TAPER TAP RUNNING DOWN	EA	3.79		
MH-T03002	OBA 2ND TAP RUNNING DOWN	EA	3.05		
MH-T03003	OBA PLUG TAP RUNNING DOWN	EA	3.79		
MH-T03008	2BA 2ND TAP RUNNING DOWN	EA	6.41		
MH-T03009	2BA PLUG TAP RUNNING DOWN	EA	6.78		
MH-T03010	3BA TAPER TAP RUNNING DOWN	EA	7.43		









L2 STORES CATALOGUE

TOOLS (various) - T



MH-T03011	3BA 2ND TAP RUNNING DOWN	EA	7.43		
MH-T03012	3BA PLUG TAP RUNNING DOWN	EA	5.01		
MH-T03013	4BA TAPER TAP RUNNING DOWN	EA	6.41		
MH-T03016	5BA TAPER TAP RUNNING DOWN	EA	12.57		
MH-T03017	5BA 2ND TAP RUNNING DOWN	EA	5.26		
MH-T03018	5BA PLUG TAP RUNNING DOWN	EA	9.66		
MH-T03019	6BA TAPER TAP RUNNING DOWN	EA	3.99		
MH-T03020	6BA 2ND TAP RUNNING DOWN	EA	3.99		
MH-T03021	6BA PLUG TAP RUNNING DOWN	EA	7.97		
MH-T03025	8BA TAPER TAP RUNNING DOWN	EA	14.79		

L2 STORES CATALOGUE

TOOLS (various) - T

MH-T03026	8BA 2ND TAP RUNNING DOWN	EA	12.29		
MH-T03027	8BA PLUG TAP RUNNING DOWN	EA	14.79		
MH-T03028	9BA TAPER TAP RUNNING DOWN	EA	16.27		
MH-T03029	9BA 2ND TAP RUNNING DOWN	EA	16.27		
MH-T03030	9BA PLUG TAP RUNNING DOWN	EA	16.27		
MH-T03031	10BA TAPER TAP RUNNING DOWN	EA	30.00		
MH-T03032	10BA 2ND TAP RUNNING DOWN	EA	26.63		
MH-T03050	OBA DIE RUNNING DOWN	EA	18.84		
MH-T03052	2BA DIE RUNNING DOWN	EA	37.30		

MH-T04 BSW TAPS & DIES

MH-T04005	3/16" BSW TAPER TAP RUNNING DOWN	EA	8.81		
Code	Product	Unit	Std. cost		
MH-T04006	3/16" BSW 2ND TAP RUNNING DOWN	EA	7.49		

L2 STORES CATALOGUE











TOOLS (various) - T

MH-T04007	3/16" BSW PLUG TAP RUNNING DOWN	EA	7.49		
MH-T04011	5/16" TAPER TAP RUNNING DOWN	EA	10.35		
MH-T04012	5/16" BSW 2ND TAP RUNNING DOWN	EA	10.32		
MH-T04013	5/16" BSW PLUG TAP RUNNING DOWN	EA	10.62		
MH-T04017	7/16" BSW TAPER TAP RUNNING DOWN	EA	7.97		
MH-T04018	7/16" BSW 2ND TAP RUNNING DOWN	EA	16.47		
MH-T04020	1/2" BSW TAPER TAP RUNNING DOWN	EA	13.71		
MH-T04021	1/2" BSW 2ND TAP RUNNING DOWN	EA	15.25		
MH-T04022	1/2" BSW PLUG TAP RUNNING DOWN	EA	11.98		
MH-T04023	9/16" BSW TAPER TAP RUNNING DOWN	EA	9.91		
MH-T04024	9/16" BSW 2ND TAP RUNNING DOWN	EA	9.91		
MH-T04025	9/16" BSW PLUG TAP RUNNING DOWN	EA	9.91		



L2 STORES CATALOGUE

TOOLS (various) - T



MH-T04026	3/4" BSW TAPER TAP RUNNING DOWN	EA	18.29		
MH-T04027	3/4" BSW 2ND TAP RUNNING DOWN	EA	18.29		
MH-T04028	3/4" BSW PLUG TAP RUNNING DOWN	EA	18.29		
MH-T04029	1" BSW TAPER TAP RUNNING DOWN	EA	24.67		
MH-T04030	1" BSW 2ND TAP RUNNING DOWN	EA	24.67		
MH-T04031	1" BSW PLUG TAP RUNNING DOWN	EA	24.67		
MH-T04040	1 1/2" BSW TAPER TAP RUNNING DOWN	EA	68.04		
MH-T04041	1 1/2" BSW PLUG TAP RUNNING DOWN	EA	68.04		
MH-T04050	1/4" BSW DIE RUNNING DOWN	EA	36.03		
MH-T04051	5/16" BSW DIE RUNNING DOWN	EA	22.96		
MH-T04052	3/8" BSW DIE RUNNING DOWN	EA	32.99		
MH-T04053	7/16" BSW DIE RUNNING DOWN	EA	21.89		





L2 STORES CATALOGUE

TOOLS (various) - T



MH-T04054	1/2" BSW DIE RUNNING DOWN	EA	18.98		
-----------	---------------------------	----	-------	---	--

MH-T05 BSP & BSB TAPS

MH-T05000	1/8" BSP 2ND TAP RUNNING DOWN	EA	18.06		
MH-T05005	3/8" BSP 2ND TAP RUNNING DOWN	EA	24.42		

<u>Code</u>	<u>Product</u>	<u>Unit</u>	<u>Std. cost</u>		
MH-T05007	1" BSP TAPER TAP RUNNING DOWN	EA	73.94		
MH-T05008	1" BSP 2ND TAP RUNNING DOWN	EA	86.21		
MH-T05009	1" BSP PLUG TAP RUNNING DOWN	EA	34.58		
MH-T05020	1/2" BSB TAPER TAP RUNNING DOWN	EA	6.87		
MH-T05021	1/2" BSB PLUG TAP RUNNING DOWN	EA	15.71		











MD-T06 FILES (various)

MD-T06001	4" FLAT SMOOTH FILE	EA	3.15		
MD-T06002	6" FLAT SMOOTH FILE	EA	2.91		
MD-T06003	8" FLAT SMOOTH FILE	EA	4.97		



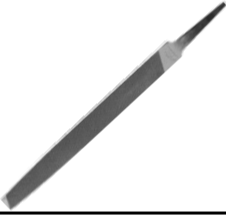
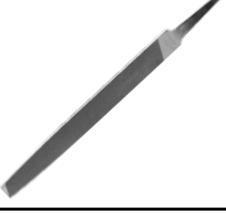
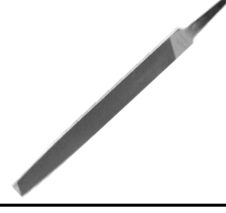
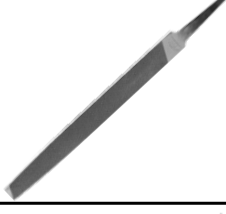







L2 STORES CATALOGUE

TOOLS (various) - T

MD-T06004	10" FLAT SMOOTH FILE	EA	5.68		
MD-T06005	12" FLAT SMOOTH FILE	EA	5.85		
MD-T06006	6" FLAT 2ND CUT FILE	EA	1.32		
MD-T06007	8" FLAT 2ND CUT FILE	EA	2.05		
MD-T06008	10" FLAT 2ND CUT FILE	EA	5.57		
MD-T06009	12" FLAT 2ND CUT FILE	EA	17.44		
MD-T06010	6" FLAT BASTARD FILE	EA	7.62		
MD-T06011	8" FLAT BASTARD FILE	EA	4.06		
MD-T06012	10" FLAT BASTARD FILE	EA	5.33		
MD-T06013	14" FLAT BASTARD FILE	EA	5.77		
MD-T06020	8" HALF ROUND SMOOTH FILE	EA	6.48		
MD-T06021	10" HALF ROUND SMOOTH FILE	EA	8.01		

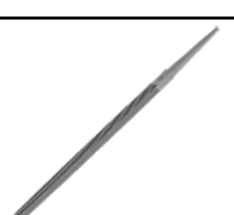
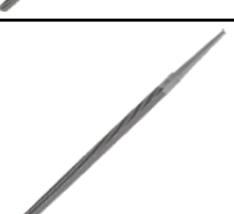
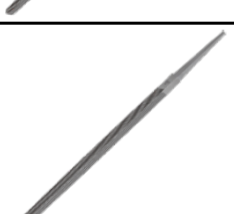
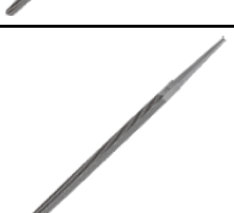
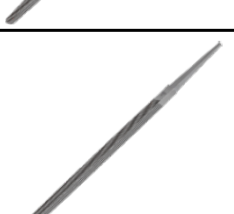

L2 STORES CATALOGUE



TOOLS (various) - T

MD-T06022	12" HALF ROUND SMOOTH FILE	EA	11.58		
MD-T06023	6" HALF ROUND 2ND CUT FILE	EA	1.44		
MD-T06024	8" HALF ROUND 2ND CUT FILE	EA	3.02		
MD-T06025	12" HALF ROUND 2ND CUT FILE	EA	6.90		
MD-T06026	6" HALF ROUND BASTARD FILE	EA	5.06		
MD-T06027	10" HALF ROUND BASTARD FILE	EA	7.60		
MD-T06028	12" HALF ROUND BASTARD FILE	EA	11.34		
MD-T06033	8" SMOOTH SQUARE FILE	EA	7.12		
MD-T06034	12" SMOOTH SQUARE FILE	EA	7.12		
MD-T06035	8" SQUARE 2ND CUT FILE	EA	4.17		
MD-T06036	10" SQUARE 2ND CUT FILE	EA	5.90		
MD-T06037	12" SQUARE 2ND CUT FILE	EA	8.39		

L2 STORES CATALOGUE

TOOLS (various) - T

MD-T06038	8" SQUARE BASTARD FILE	EA	5.61		
MD-T06039	10" SQUARE BASTARD FILE	EA	5.61		
MD-T06040	12" SQUARE BASTARD FILE	EA	13.43		

<u>Code</u>	<u>Product</u>	<u>Unit</u>	<u>Std. cost</u>		
MD-T06041	14" SQUARE BASTARD FILE	EA	7.00		
MD-T06042	8" ROUND SMOOTH FILE	EA	4.37		
MD-T06043	6" ROUND 2ND CUT FILE	EA	6.55		
MD-T06054	8" ROUND 2ND CUT FILE	EA	2.17		
MD-T06055	10" ROUND 2ND CUT FILE	EA	9.12		
MD-T06056	10" ROUND BASTARD FILE	EA	4.80		
MD-T06070	8" TRIANGULAR 2ND CUT FILE	EA	4.89		
MD-T06081	NUMBER 9 RIFFLER FILE RUNNING DOWN	EA	0.95		
MD-T06082	NUMBER 10 RIFFLER FILE RUNNING DOWN	EA	0.95		

L2 STORES CATALOGUE

TOOLS (various) - T













MD-T06090	NEEDLE FILE SETS (6)	EA	16.07		
MD-T06095	4" FILE HANDLES WOOD	EA	1.44		
MD-T06096	5" FILE HANDLES WOOD	EA	0.92		
MD-T06097	6" FILE HANDLES WOOD	EA	1.05		
MD-T06100	TRUEGRIT HAND FILE 10" LONG	EA	14.46		
MD-T06102	60g EMERY STRIP FOR T/GRIT	EA	0.69		
MD-T06104	120g EMERY STRIP FOR T/GRIT	EA	0.44		

MH-T07 ALLEN KEYS

MH-T07001	1.27mm ALLEN KEY	EA	0.17		
MH-T07002	1.5mm ALLEN KEY	EA	0.55		
MH-T07003	2.0mm ALLEN KEY	EA	0.14		
MH-T07004	2.5mm ALLEN KEY	EA	0.14		









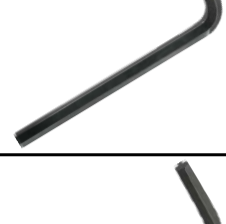
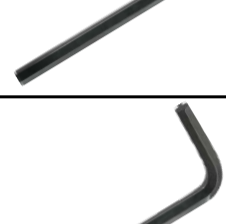

L2 STORES CATALOGUE

TOOLS (various) - T

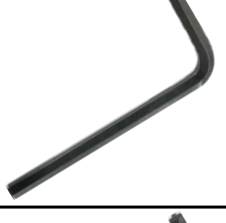
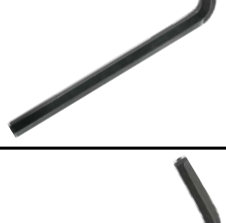
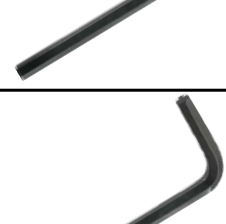
MH-T07005	3.0mm ALLEN KEY	EA	0.35		
MH-T07006	4.0mm ALLEN KEY	EA	0.30		
MH-T07007	5.0mm ALLEN KEY	EA	0.90		
MH-T07008	6.0mm ALLEN KEY	EA	0.46		
MH-T07009	7.0mm ALLEN KEY	EA	0.94		
MH-T07012	8.0mm ALLEN KEY	EA	0.91		
MH-T07013	10.0mm ALLEN KEY	EA	1.13		
MH-T07014	ALLEN KEY SETS METRIC /IMP 20 PCE	EA	26.82		
MH-T07015	ALLEN KEY SETS L/REACH METRIC	EA	22.87		
MH-T07020	0.050 (AF) ALLEN KEY	EA	0.17		
MH-T07021	1/16"(AF) ALLEN KEY	EA	0.18		
MH-T07022	5/64"(AF) ALLEN KEY	EA	0.17		









L2 STORES CATALOGUE

TOOLS (various) - T









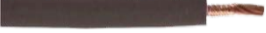

<u>Code</u>	<u>Product</u>	<u>Unit</u>	<u>Std. cost</u>		
MH-T07023	3/32"(AF) ALLEN KEY	EA	0.19		
MH-T07024	1/8" (AF) ALLEN KEY	EA	0.20		
MH-T07025	5/32"(AF) ALLEN KEY	EA	0.27		
MH-T07026	3/16"(AF) ALLEN KEY	EA	0.39		
MH-T07027	7/32"(AF) ALLEN KEY	EA	0.54		
MH-T07028	1/4" (AF) ALLEN KEY	EA	0.94		
MH-T07029	5/16"(AF) ALLEN KEY	EA	1.15		
MH-T07030	3/8" (AF) ALLEN KEY	EA	1.64		
MH-T07031	1/2" (AF) ALLEN KEY	EA	3.57		
MH-T07032	9/16" (AF) ALLEN KEY	EA	5.09		
MH-T07034	ALLEN KEY SETS L/RCH IMPERIAL	EA	14.77		
MH-T07039	TORX KEY T15	EA	3.04		

MH-T07041	10-PCE TORX TAMPER-PROOFBIT SET	EA	11.43		
-----------	---------------------------------	----	-------	---	--













<u>Code</u>	<u>Product</u>	<u>Unit</u>	<u>Std. cost</u>	
V	<u>ELECTRICAL INVENTORY</u>			
V01	<u>SINGLE TRI-RATED CABLE</u>			
MZ-V01000	(100 Metre Reel of) 1.0mm SINGLE BROWN TRI-RATED CABLE	RL	£23.52	
MZ-V01001	(100 Metre Reel of) 1.0mm SINGLE BLACK TRI-RATED CABLE	RL	£23.52	
MZ-V01002	(100 Metre Reel of) 1.0mm SINGLE GREY TRI-RATED CABLE	RL	£23.52	
MZ-V01003	(100 Metre Reel of) 1.0mm SINGLE BLUE TRI-RATED CABLE	RL	£23.52	
MZ-V01004	(100 Metre Reel of) 1.0mm SINGLE GREEN/YELLOW TRI-RATED CABLE	RL	£23.52	
MZ-V01005	(100 Metre Reel of) 1.5mm SINGLE BROWN TRI-RATED CABLE	RL	£20.00	
MZ-V01006	(100 Metre Reel of) 1.5mm SINGLE BLACK TRI-RATED CABLE	RL	£20.00	
MZ-V01007	(100 Metre Reel of) 1.5mm SINGLE GREY TRI-RATED CABLE	RL	£20.00	
MZ-V01008	(100 Metre Reel of) 1.5mm SINGLE BLUE TRI-RATED CABLE		£20.00	









MZ-V01009	(100 Metre Reel of) 1.5mm SINGLE GREEN/YELLOW TRI-RATED CABLE	RL	£20.00	
MZ-V01015	(100 Metre Reel of) 2.5mm SINGLE BROWN TRI-RATED CABLE	RL	£31.32	
MZ-V01016	(100 Metre Reel of) 2.5mm SINGLE BLACK TRI-RATED CABLE	RL	£31.32	
MZ-V01017	(100 Metre Reel of) 2.5mm SINGLE GREY TRI-RATED CABLE	RL	£31.32	
MZ-V01018	(100 Metre Reel of) 2.5mm SINGLE BLUE TRI-RATED CABLE	RL	£31.32	
MZ-V01019	(100 Metre Reel of) 2.5mm SINGLE GREEN/YELLOW TRI-RATED CABLE	RL	£31.32	
MZ-V01020	(100 Metre Reel of) 4.0mm SINGLE BROWN TRI-RATED CABLE	RL	£48.72	
MZ-V01021	(100 Metre Reel of) 4.0mm SINGLE BLACK TRI-RATED CABLE	RL	£48.72	
MZ-V01022	(100 Metre Reel of) 4.0mm SINGLE GREY TRI-RATED CABLE	RL	£48.72	
MZ-V01023	(100 Metre Reel of) 4.0mm SINGLE BLUE TRI-RATED CABLE	RL	£48.72	



MZ-V01024	(100 Metre Reel of) 4.0mm SINGLE GREEN/YELLOW TRI-RATED CABLE	RL	£48.72	
MZ-V01030	(100 Metre Reel of) 6.0mm SINGLE BROWN TRI-RATED CABLE	RL	£90.48	
MZ-V01031	(100 Metre Reel of) 6.0mm SINGLE BLACK TRI-RATED CABLE	RL	£90.48	
MZ-V01032	(100 Metre Reel of) 6.0mm SINGLE GREY TRI-RATED CABLE	RL	£90.48	
MZ-V01033	(100 Metre Reel of) 6.0mm SINGLE BLUE TRI-RATED CABLE	RL	£90.48	
MZ-V01034	(100 Metre Reel of) 6.0mm SINGLE GREEN/YELLOW TRI-RATED CABLE	RL	£90.48	
MZ-V01040	(100 Metre Reel of) 10.0mm SINGLE BROWN TRI-RATED CABLE	RL	£126.00	
MZ-V01041	(100 Metre Reel of) 10.00mm SINGLE BLACK TRI-RATED CABLE	RL	£126.00	
MZ-V01042	(100 Metre Reel of) 10.0mm SINGLE GREY TRI-RATED CABLE	RL	£116.58	
MZ-V01043	(100 Metre Reel of) 10.0mm SINGLE BLUE TRI-RATED CABLE	RL	£116.58	









MZ-V01044	(100 Metre Reel of) 10.0mm SINGLE GREEN/YELLOW TRI-RATED CABLE	RL	£116.37	
MZ-V01050	(100 Metre Reel of 0.75MM SINGLE CABLE BROWN TRIRATED	RL	£24.00	
MZ-V01051	(100 Metre Reel of 0.75MM SINGLE CABLE BLACK TRIRATED	RL	£24.00	
MZ-V01052	(100 Metre Reel of 0.75MM SINGLE CABLE GREY TRIRATED	RL	£24.00	
MZ-V01053	(100 Metre Reel of 0.75MM SINGLE CABLE BLUE TRIRATED	RL	£24.00	
MZ-V01054	(100 Metre Reel of 0.75MM SINGLE CABLE GREEN/YELLOW TRIRATED	RL	£24.00	

V02

FLEXIBLE MAINS CABLE

MS-V02001	0.75mm 2-CORE ORANGE 6A CABLE	M	£0.41	
MS-V02002	0.75mm 3-CORE BLACK 6A CABLE	M	£0.43	
MS-V02003	0.75mm 3-CORE WHITE 6A CABLE	M	£0.50	
MS-V02003A	0.75mm 2-CORE WHITE 6A CABLE	M	£0.35	







MS-V02004	0.75mm 3-CORE ORANGE 6A CABLE	M	£0.69	
MS-V02005	1.0mm 2-CORE ORANGE 15A CABLE	M	£0.41	
MS-V02006	1.0mm 3-CORE BLACK 10A CABLE	M	£0.52	
MS-V02007	1.0mm 3-CORE WHITE 10A CABLE	M	£0.45	
MS-V02008	1.0mm 3-CORE ORANGE 10A CABLE	M	£0.52	
MS-V02009	1.0mm 4-CORE BLACK 10A CABLE	M	£0.49	
MS-V02010	1.0mm 5-CORE BLACK 10A CABLE	M	£1.84	
MS-V02030	1.5mm 3-CORE ORANGE 15A CABLE	M	£0.66	
MS-V02031	1.5mm 3-CORE BLACK 15A CABLE	M	£0.66	
MS-V02032	1.5mm 2-CORE ORANGE 15A CABLE	M	£0.66	



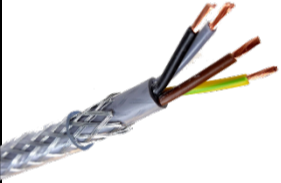

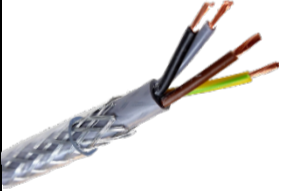
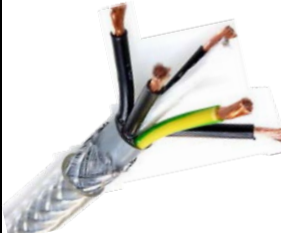
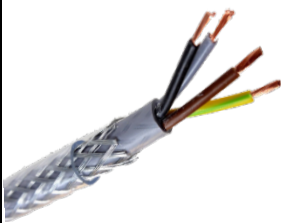
MS-V02033	1.5mm 3-CORE WHITE 15A CABLE	M	£0.92	
MS-V02034	1.5mm 4-CORE WHITE CABLE	M	£0.87	
MS-V02035	1.5mm 5-CORE WHITE CABLE	M	£2.08	
MS-V02037	2.5mm 3-CORE WHITE CABLE	M	£0.95	

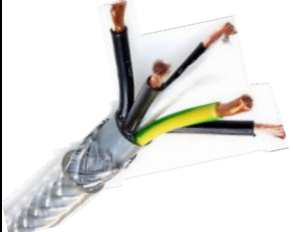

V03 **FLEX ARMoured SY / YY CABLE**

MB-V03001	1.0mm 4-CORE SY CABLE	M	£1.39	
MB-V03002	1.0mm 5-CORE SY CABLE	M	£1.22	
MB-V03003	1.5mm 4 CORE SY CABLE	M	£1.68	
MB-V03004	1.5mm 5-CORE SY CABLE	M	£1.57	
MB-V03005	2.5mm 4-CORE SY CABLE	M	£1.95	
MB-V03006	2.5mm 5-CORE SY CABLE	M	£2.97	



MB-V03007	4.0mm 5-CORE SY CABLE	M	£3.47	
MB-V03009	6.0mm 5-CORE SY CABLE	M	£4.97	

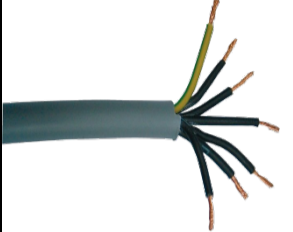
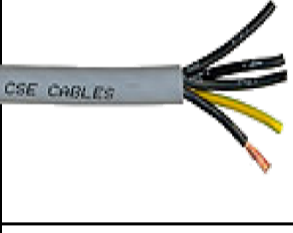

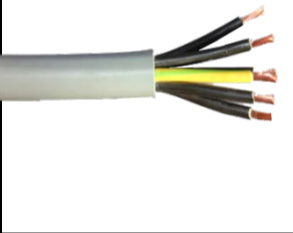
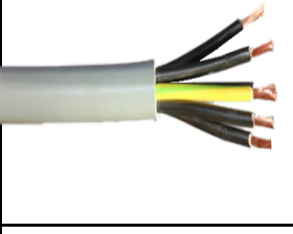
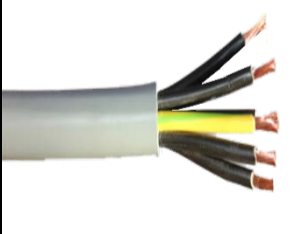
<u>Code</u>	<u>Product</u>	<u>Unit</u>	<u>Std. cost</u>	
-------------	----------------	-------------	------------------	--

MB-V03020	0.75mm 7-CORE YY CONTROL FLEX CABLE	M	£1.13	
MB-V03021	2.5mm 5-CORE YY CONTROL FLEX CABLE	M	£1.66	
MB-V03022	4.0mm 5-CORE YY CONTROL FLEX CABLE	M	£3.22	
MB-V03023	6.0mm 5-CORE YY CONTROL FLEX CABLE	M	£4.69	
MB-V03024	10.0mm 5-CORE YY CONTROL FLEX CABLE	M	£8.70	
MB-V03025	16.0mm 5-CORE YY CONTROL FLEX CABLE	M	£11.91	



<u>V04</u>	<u>LSF CABLE</u>			
------------	------------------	--	--	--

MB-V04005	1.0mm WHITE LSF CABLE	M	£0.50	
-----------	-----------------------	---	-------	---



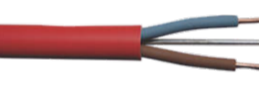

MB-V04006	1.5mm WHITE LSF CABLE	M	£0.60	
MB-V04007	2.5mm WHITE LSF CABLE	M	£0.99	
MB-V04008	4.0mm WHITE LSF CABLE	M	£1.17	

V05 MISCELLANEOUS CABLE

MB-V05001	0.75mm HOFR CABLE	M	£1.33	
MB-V05002	1.5mm 2 CORE AND EARTH RED FIRESURE CABLE	M	£1.93	
MB-V05003	1.5mm HOFR CABLE	M	£1.09	
MB-V05005	4.0mm 3-CORE 30A RUBBER CABLE	M	£2.57	

V06 20mm CONDUIT & ACCESSORIES

MB-V06020	20mm WHITE PVC CONDUIT (RUNNING DOWN)	EA	£1.70	
MB-V06022	20mm WHITE PVC TEE BOX (RUNNING DOWN)	EA	£1.50	





MB-V06023	20mm WHITE PVC THROUGH BOX (RUNNING DOWN)	EA	£1.60	
MB-V06024	20mm WHITE PVC ANGLE BOX (RUNNING DOWN)	EA	£1.60	
MB-V06025	20mm WHITE PVC END BOX (RUNNING DOWN)	EA	£1.46	
MB-V06026	20mm WHITE PVC SPACER BAR SADDLE (RUNNING DOWN)	EA	£0.27	
MB-V06027	20mm WHITE PVC SPRING SADDLE (RUNNING DOWN)	EA	£0.32	
MB-V06028	20/25mm WHITE PVC BOX LID (RUNNING DOWN)	EA	£0.41	
MB-V06029	20mm WHITE PVC INSPECTION ELBOW (RUNNING DOWN)	EA	£1.10	
MB-V06060	20mm GALVANISED CONDUIT	EA	£7.39	
MB-V06061	20mm GALVANISED INSPECTION ELBOW	EA	£1.63	
MB-V06062	20mm GALVANISED TEE BOX	EA	£1.94	











MB-V06063	20mm GALVANISED THROUGH BOX	EA	£1.63	
MB-V06064	20mm GALVANISED ANGLE BOX	EA	£1.63	
MB-V06065	20mm GALVANISED TERMINAL BOX	EA	£1.34	
MB-V06066	20mm GALVANISED DISTANCE SADDLE	EA	£1.30	
MB-V06067	20/25mm GALVANISED BOX LID	EA	£0.29	
MB-V06068	20mm GALVANISED SPACER BAR SADDLE	EA	£0.22	
MB-V30001	M4 x 6 SCREWS FOR CONDUIT LIDS	EA	£0.06	

V07 **25mm CONDUIT & ACCESSORIES**

MB-V07020	25mm WHITE PVC CONDUIT (RUNNING DOWN)	EA	£2.08	
MB-V07022	25mm WHITE PVC TEE BOX (RUNNING DOWN)	EA	£2.71	



MB-V07023	25mm WHITE PVC THROUGH BOX (RUNNING DOWN)	EA	£4.10	
MB-V07024	25mm WHITE PVC ANGLE BOX (RUNNING DOWN)	EA	£2.45	
MB-V07025	25mm WHITE PVC END BOX (RUNNING DOWN)	EA	£2.24	
MB-V07026	25mm WHITE PVC SPACER BAR SADDLE (RUNNING DOWN)	EA	£0.45	
MB-V07027	25mm WHITE PVC INSPECTION ELBOW (RUNNING DOWN)	EA	£3.94	
MB-V07047	25mm GALVANISED SADDLE (DISTANCE)	EA	£1.23	

<u>Code</u>	<u>Product</u>	<u>Unit</u>	<u>Std. cost</u>	
MB-V07060	25mm GALVANISED CONDUIT	EA	£8.57	
MB-V07069	25mm GALVANISED SPACER BAR SADDLE	EA	£0.33	
MB-V07071	25mm GALVANISED TEE BOX	EA	£5.53	













MB-V07072	25mm GALVANISED THROUGH BOX	EA	£2.40	
MB-V07073	25mm GALVANISED ANGLE BOX	EA	£2.55	
MB-V07074	25mm GALVANISED TERMINAL BOX	EA	£2.40	
MB-V07075	25mm GALVANISED INSPECTION ELBOW	EA	£2.73	
MB-V30001	M4 x 6 SCREWS FOR CONDUIT LIDS	EA	£0.06	



V08 **INSULATED CABLE CRIMP**

MB-V08001	(Pack of 100) 3.7mm RED INS RING TERMINAL	PCK	£3.21	
MB-V08002	(Pack of 100) 4.0mm RED INS RING TERMINAL	PCK	£4.89	
MB-V08003	(Pack of 100) 5.0mm RED INS RING TERMINAL	PCK	£3.63	
MB-V08005	(Pack of 100) 6.0mm RED INS RING TERMINAL	PCK	£6.30	
MB-V08008	(Pack of 100) 8.5mm RED INS RING TERMINAL	PCK	£6.93	



MB-V08010	(Pack of 100) RED THROUGH CONNECTORS	PCK	£5.48	
MB-V08012	(Pack of 100) 18mm RED SLEEVE BLADE	PCK	£12.18	
MB-V08014	(Pack of 100) 10.0mm RED SLEEVE PIN	PCK	£8.70	
MB-V08016	(Pack of 100) RED INS MALE PUSH ON	PCK	£6.21	
MB-V08017	(Pack of 100) RED INS FEMALE PUSH ON	PCK	£8.00	
MB-V08018	(Pack of 100) 6.5mm RED INS FORK TERMINAL	PCK	£10.44	
MB-V08020	(Pack of 100) 4.0mm RED INS FORK TERMINAL	PCK	£10.44	
MB-V08021	(Pack of 100) 3.7mm RED INS FORK TERMINAL	PCK	£6.09	
MB-V08022	(Pack of 100) 3.2mm RED INS FORK TERMINAL	PCK	£4.45	
MB-V08024	(Pack of 100) 0.25" RED SLEEVE PIGGYBACK	PCK	£15.66	



MB-V08030	(Pack of 100) 3.7mm BLUE INS RING TERMINAL	PCK	£8.70	
MB-V08031	(Pack of 100) 4.0mm BLUE INS RING TERMINAL	PCK	£4.01	
MB-V08032	(Pack of 100) 5.0mm BLUE INS RING TERMINAL	PCK	£4.01	
MB-V08033	(Pack of 100) 6.0mm BLUE INS RING TERMINAL	PCK	£7.72	
MB-V08034	(Pack of 100) 8.5mm BLUE INS RING TERMINAL	PCK	£12.18	
MB-V08042	(Pack of 100) BLUE THROUGH CONNECTORS	PCK	£6.80	
MB-V08044	(Pack of 100) 18.0mm BLUE SLEEVE BLADE	PCK	£7.66	
MB-V08046	(Pack of 100) BLUE SLEEVE PIN	PCK	£5.22	
MB-V08048	(Pack of 100) BLUE INS MALE PUSH ON	PCK	£15.66	
MB-V08050	(Pack of 100) BLUE INS FEMALE PUSH ON	PCK	£6.83	













MB-V08051	(Pack of 100) 6.5mm BLUE INS FORK TERMINAL	PCK	£8.70	
MB-V08052	(Pack of 100) 5.0mm BLUE INS FORK TERMINAL	PCK	£4.53	
MB-V08053	(Pack of 100) 4.0mm BLUE INS FORK TERMINAL	PCK	£8.70	
MB-V08054	(Pack of 100) 3.7mm BLUE INS FORK TERMINAL	PCK	£10.44	
MB-V08056	(Pack of 100) BLUE SLEEVE PIGGYBACK	PCK	£13.92	
MB-V08058	(Pack of 100) BLUE BULLET - MALE CRIMP	PCK	£6.94	
MB-V08060	(Pack of 100) BLUE BULLET - FEMALE CRIMP	PCK	£20.88	
MB-V08075	(Pack of 100) 4.3mm YELLOW INS FORK TERMINAL	PCK	£10.44	
MB-V08076	(Pack of 100) 5.0mm YELLOW INS FORK TERMINAL	PCK	£15.66	
MB-V08077	(Pack of 100) 6.0mm YELLOW INS FORK TERMINAL	PCK	£13.92	













MB-V08078	(Pack of 100) 4.3mm YELLOW INS RING TERMINAL	PCK	£8.12	
MB-V08079	(Pack of 100) 5.0mm YELLOW INS RING TERMINAL	PCK	£15.66	
MB-V08080	(Pack of 100) 6.0mm YELLOW INS RING TERMINAL	PCK	£30.15	
MB-V08081	(Pack of 100) 8.0mm YELLOW INS RING TERMINAL	PCK	£10.14	
MB-V08082	(Pack of 100) 10.5mm YELLOW INS RING TERMINAL	PCK	£10.44	
MB-V08086	(Pack of 100) YELLOW BUTT CONNECTORS	PCK	£19.14	
MB-V08088	(Pack of 100) 10.0mm YELLOW SLEEVE BLADE	PCK	£13.92	
MB-V08090	(Pack of 100) 14.0mm YELLOW SLEEVE PIN	PCK	£17.40	
MB-V08092	(Pack of 100) YELLOW INS MALE PUSH ON	PCK	£17.40	
MB-V08094	(Pack of 100) YELLOW FEMALE PUSH ON	PCK	£8.14	



MB-V09000	CABLE SHOES 10-5 UNINSULATED	EA	£0.40	
MB-V09001	CABLE SHOES 10-6 UNINSULATED	EA	£0.22	
MB-V09002	CABLE SHOES 10-8 UNINSULATED	EA	£0.23	
MB-V09003	CABLE SHOES 10-10 UNINSULATED	EA	£0.26	
MB-V09004	CABLE SHOES 16-5 UNINSULLATED	EA	£0.29	
MB-V09005	CABLE SHOES 16-6 UNINSULATED	EA	£0.32	
MB-V09006	CABLE SHOES 16-8 UNINSULATED	EA	£0.36	

<u>Code</u>	<u>Product</u>	<u>Unit</u>	<u>Std. cost</u>	
MB-V09007	CABLE SHOES 16-10 UNINSULATED	EA	£0.35	
MB-V09008	CABLE SHOES 16-12 UNINSULATED	EA	£0.43	
MB-V09012	CABLE SHOES 25-6 UNINSULATED	EA	£0.62	



MB-V09013	CABLE SHOES 25-8 UNINSULATED	EA	£0.57	
MB-V09014	CABLE SHOES 25-10 UNINSULATED	EA	£0.52	
MB-V09015	CABLE SHOES 25-12 UNINSULATED	EA	£0.45	
MB-V09020	CABLE SHOES 35-6 UNINSULATED	EA	£0.71	
MB-V09021	CABLE SHOES 35-8 UNINSULATED	EA	£0.43	
MB-V09022	CABLE SHOES 35-10 UNINSULATED	EA	£0.53	
MB-V09023	CABLE SHOES 35-12 UNINSULATED	EA	£0.71	
MB-V09028	CABLE SHOES 50-10 UNINSULATED	EA	£0.97	
MB-V09029	CABLE SHOES 50-12 UNINSULATED	EA	£0.95	
MB-V09031	CABLE SHOES 70-10 UNINSULATED	EA	£1.39	



MB-V09032	CABLE SHOES 70-12 UNINSULATED	EA	£1.47	
-----------	-------------------------------	----	-------	---



V10 FUSE & CARRIERS

MB-V10001	T1A 20mm CARTRIDGE FUSE	EA	£0.33	
MB-V10002	2A BS1362 CARTRIDGE FUSE	EA	£0.12	
MB-V10003	3A BS1362 CARTRIDGE FUSE	EA	£0.12	
MB-V10004	5A BS1362 CARTRIDGE FUSE	EA	£0.13	
MB-V10007	13A BS1362 CARTRIDGE FUSE	EA	£0.34	
MB-V10044	FUSE GEN PURPOSE TYPEgG/GI 2 amp	EA	£0.83	
MB-V10045	FUSE GEN PURP TYPE Gg/GI 6 AMP	EA	£0.85	
MB-V10046	FUSE GEN PURP TYPE Gg/GI 10 AMP	EA	£1.06	
MB-V10047	FUSE GEN PURP TYPE Gg/GI 16 AMP	EA	£0.85	









MB-V10048	FUSE GEN PURP TYPE gG/gL 20AMP	EA	£1.11	
MB-V10049	FUSE GEN PURP TYPEgG/GI 32 AMP	EA	£1.11	
MB-V10060	20 x 5mm 50MA QUICKBLOW GLASS FUSE	EA	£0.69	
MB-V10061	20 x 5mm 100MA QUICKBLOW GLASS FUSE	EA	£0.60	
MB-V10062	20 x 5mm 250MA QUICKBLOW GLASS FUSE	EA	£0.73	
MB-V10063	20 x 5mm 500MA QUICKBLOW GLASS FUSE	EA	£0.24	
MB-V10064	20 x 5mm 1A QUICKBLOW GLASS FUSE	EA	£0.27	
MB-V10065	20 x 5mm 1.6A QUICKBLOW GLASS FUSE	EA	£0.23	
MB-V10066	20 x 5mm 2A QUICKBLOW GLASS FUSE	EA	£0.13	
MB-V10067	20 x 5mm 2.5A QUICKBLOW GLASS FUSE	EA	£0.29	



MB-V10068	20 x 5mm 3.15A QUICKBLOW GLASS FUSE	EA	£0.15	
MB-V10069	20 x 5mm 5A QUICKBLOW GLASS FUSE	EA	£0.15	

V11 **CABLE CLIPS & TIES**

MS-V11001	(Box of 100) 4mm WHITE ROUND CABLE CLIPS	BOX	£3.94	
MS-V11002	(Box of 100) 5mm WHITE ROUND CABLE CLIPS (RUNNING DOWN)	BOX	£3.23	
MS-V11003	(Box of 100) 6mm BLACK ROUND CABLE CLIPS (RUNNING DOWN)	BOX	£2.80	
MS-V11004	(Box of 100) 7mm WHITE ROUND CABLE CLIPS (RUNNING DOWN)	BOX	£3.07	
MS-V11005	(Box of 100) 8mm WHITE ROUND CABLE CLIPS (RUNNING DOWN)	BOX	£2.65	
MS-V11007	(Box of 100) 10mm WHITE ROUND CABLE CLIPS (RUNNING DOWN)	BOX	£4.95	
MS-V11008	(Box of 100) 11mm WHITE ROUND CABLE CLIPS (RUNNING DOWN)	BOX	£4.95	





MS-V11009	(Box of 100) 3 - 5mm WHITE RND CABLE CLIPS (RUNNING DOWN)	BOX	£3.48	
MS-V11010	(Box of 100) 5 - 7mm WHITE FLAT CABLE CLIP (RUNNING DOWN)	BOX	£5.72	
MS-V11013	(Box of 100) 2 x 4mm FLAT CABLE CLIP GREY (RUNNING DOWN)	BOX	£2.27	
MS-V11014	(Box of 100) 5 x 8mm FLAT CABLE CLIP GREY (RUNNING DOWN)	BOX	£3.01	
MS-V11015	(Box of 100) 6 x 10mm FLAT CABLE CLIP WHITE (RUNNING DOWN)	BOX	£3.39	
MS-V11018	SMALL ADHESIVE CABLE CLIP	EA	£0.19	
MS-V11019	LARGE ADHESIVE CABLE CLIP	EA	£0.18	
MS-V11029	(Pack of 100) 100mm BLACK CABLE TIES	PCK	£0.43	
MS-V11030	(Pack of 100) 150mm BLACK CABLE TIES	PCK	£0.88	





MS-V11032	(Pack of 250) 200mm COLOURED CABLE TIES	PCK	£19.73	
MS-V11033	(Pack of 100) 200mm BLACK CABLE TIES	PCK	£2.14	
MS-V11034	(Pack of 100) 300mm BLACK CABLE TIES	PCK	£2.70	
MS-V11035A	(Pack of 50) 540mm HEAVY DUTY CABLE TIES	PCK	£18.82	
MS-V11036	HEAVY DUTY REUSABLE CABLE TIE	EA	£0.19	
MS-V11040	19 x 19mm STICK ON CABLE TIE BASE	EA	£0.09	
MS-V11041	29 x 29mm STICK ON CABLE TIE BASE	EA	£0.28	







<u>Code</u>	<u>Product</u>	<u>Unit</u>	<u>Std. cost</u>	
V12	LAMPS & LAMP HOLDERS			

MS-V12060	250V 500W TUNGSTEN HALOGEN	EA	£1.74	
MS-V12080	600mm T8 POLYLUX 18W/835	EA	£2.36	





MS-V12082	1200mm LAMP OSRAM T8 36W/23 G13	EA	£2.17	
MS-V12083	1500mm LAMP OSRAM 58W/835 G13	EA	£2.61	
MS-V12084	1800mm LAMP OSRAM 70W/23 G13	EA	£5.56	
MS-V12085	LAMP ORBIS 16W 2 PIN 835	EA	£3.11	
MS-V12086	LAMP ORBIS 16W 4 PIN 835	EA	£5.82	
MS-V12087	LAMP ORBIS 28W 4PIN 835	EA	£7.39	
MS-V12088	LAMP ORBIS 38W 4PIN 835	EA	£8.00	
MS-V12089	LAMP 18W DULUX-L 4PIN 840	EA	£4.35	
MS-V12090	LAMP DULUX-L 24W C/WHITE	EA	£4.78	



MS-V12091	LAMP DULUX-L 40W C/WHITE	EA	£5.48	
MS-V12092	LAMP DULUX-L 55W C/WHITE	EA	£6.17	
MS-V12097	LAMP 549MM 14W T5 840 4000K C/WHITE DELUXE	EA	£2.45	
MS-V12098	LAMP DULUX-TE26W C/WHITE LUMILUX	EA	£5.30	
MS-V12099	LAMP DULUX-TE 46W C/WHITE LUMILUX	EA	£7.18	
MS-V12100	8W/23 G5 300M WHITE	EA	£1.30	

DOMESTIC L LIGHTING LED LAMPS FOR HOME USE ONLY (CARD PAYMENT ONLY)

MS-V12110	GU10 LUCECO LAMP 5 WATT COLD WHITE NON DIM (CARD PAYMENT)	EA	£3.74	
MS-V12111	GU10 LUCECO LAMP 5W WARM WHITE NON DIM (CARD PAYMENT)	EA	£2.90	
MS-V12112	CANDLE LAMP SMALL THREAD WARM WHI 3.5W NON DIM (CARD PAYMENT)	EA	£2.24	



MS-V12113	CANDLE LAMP BAYONET 3.5W WARM WHI NON DIM (CARD PAYMENT)	EA	£2.24	
MS-V12114	SMALL BAYONET LAMP 3.5W WARM WHI NON DIM (CARD PAYMENT)	EA	£2.24	
MS-V12115	LAMP LARGE SCREW THREAD 10W WARM WHI NON DIM (CARD PAYMENT)	EA	£3.13	
MS-V12119	B/G USB SWITCH SOCKET 2 GANG WHITE (CARD PAYMENT)	EA	£13.13	

V13



CABLE GLANDS

MS-V13001	4 - 6mm (M12) CABLE GLAND	EA	£0.47	
MS-V13003	6 - 8mm (M16) CABLE GLAND	EA	£0.57	
MS-V13007	6 - 12mm (M20) CABLE GLAND	EA	£0.73	
MS-V13011	10 - 14mm (M20) CABLE GLAND	EA	£0.42	
MS-V13013	13 - 18mm (M25) CABLE GLAND (IP 68)	EA	£0.80	





MS-V13015	13 - 18mm (M25) CABLE GLAND (IP 65)	EA	£0.95	
MS-V13018	6-12mm (M20) WHITE CABLE GLAND	EA	£0.43	
MS-V13022	40MM BLACK GLAND	EA	£3.02	
MS-V13023	25-40 (M50) CABLE GLAND	EA	£5.44	
MS-V13027	M20 SY CABLE GLAND	EA	£10.52	
MS-V13028	M25 SY CABLE GLAND	EA	£18.66	
MS-V13035	GALVANISED GLAND FOR ALL SIZE OVAL CABLE	EA	£0.57	

V14 **INSULATION TAPE**

MS-V14001	BROWN PVC INSULATING TAPE	EA	£1.49	
MS-V14002	BLACK PVC INSULATING TAPE	EA	£1.49	





MS-V14004	GREY PVC INSULATING TAPE	EA	£1.49	
MS-V14005	BLUE PVC INSULATING TAPE	EA	£1.49	
MS-V14007	GREEN/YELLOW PVC INSULATING TAPE	EA	£1.49	

V15 TERMINAL BLOCKS

MS-V15002	5A TERMINAL BLOCK STRIP	EA	£1.53	
-----------	-------------------------	----	-------	---

Code **Product** **Unit** **Std. cost**

V16 PVS TRUNKING, GALVANISED CHANNEL & ACCESSORIES

MS-V16001	25 x 16mm WHITE MINI TRUNKING (RUNNING DOWN)	EA	£4.42	
MS-V16002	25 x 16mm WHITE END CAPS (RUNNING DOWN)	EA	£0.67	
MS-V16003	25 x 16mm CLIP ON COUPLING (RUNNING DOWN)	EA	£0.36	
MS-V16004	25 x 16mm INTERNAL ANGLE (RUNNING DOWN)	EA	£0.52	
MS-V16005	25 x 16mm EXTERNAL ANGLE (RUNNING DOWN)	EA	£0.59	



MS-V16006	25 x 16mm FLAT ANGLE (RUNNING DOWN)	EA	£0.75	
MS-V16007	25 x 16mm MINI TRUNKING TEE (RUNNING DOWN)	EA	£3.04	
MS-V16008	25 x 16mm WHITE ADAPTOR (RUNNING DOWN)	EA	£0.69	
MS-V16009	2 GANG CABLE TRUNKING CORNER SWITCH & SOCKET BOX	EA	£4.24	
MS-V16010	1 GANG CABLE TRUNKING CORNER SWITCH & SOCKET BOX	EA	£2.61	
MS-V16015	50 x 50mm WHITE TRUNKING (RUNNING DOWN)	EA	£48.31	
MS-V16016	50 x 50mm WHITE END CAP (RUNNING DOWN)	EA	£2.71	
MS-V16017	50 x 50mm WHITE INTERNAL COUPLING (RUNNING DOWN)	EA	£3.60	
MS-V16019	50 x 50mm WHITE FLAT ANGLE (RUNNING DOWN)	EA	£7.88	



MS-V16020	50 x 50 WHITE FLAT TEE UNIT (RUNNING DOWN)	EA	£12.94	
MS-V16021	21 x 41mm GALVANISED CHANNEL	LEN	£11.80	
MS-V16022	41 x 41mm GALVANISED CHANNEL	EA	£12.26	
MS-V16023	6.0mm CHANNEL NUT - LONG SPRING	EA	£0.29	
MS-V16024	6.0mm CHANNEL NUT - SHORT SPRING	EA	£0.29	
MS-V16025	8.0mm CHANNEL NUT - LONG SPRING	EA	£0.17	
MS-V16026	8.0mm CHANNEL NUT - SHORT SPRING	EA	£0.15	
MS-V16030	50 x 100mm WHITE PREMIER TRUNKING (RUNNING DOWN)	EA	£66.34	
MS-V16031	50 x 100mm WHITE END CAP (RUNNING DOWN)	EA	£5.72	











MS-V16032	50 x 100mm WHITE INTERNAL COUPLER (RUNNING DOWN)	EA	£5.67	
MS-V16033	50 x 100mm WHITE INTERNAL ANGLE (RUNNING DOWN)	EA	£22.72	
MS-V16034	50 x 100mm WHITE EXTERNAL ANGLE (RUNNING DOWN)	EA	£18.02	
MS-V16035	50 x 100mm WHITE FLAT TEE (RUNNING DOWN)	EA	£27.12	
MS-V16036	50 x 100mm WHITE FLAT ANGLE (RUNNING DOWN)	EA	£25.34	
MS-V16037	50 x 100mm WHITE JOINT COVER (RUNNING DOWN)	EA	£6.75	
MS-V16040	1 GANG WHITE OUTLET BOX (RUNNING DOWN)	EA	£3.40	
MS-V16041	2 GANG WHITE OUTLET BOX (RUNNING DOWN)	EA	£4.14	
MS-V16044	25 x 40mm OPEN SLOT PANEL TRUNKING	EA	£12.02	



MS-V16045	40 x 40mm OPEN SLOT PANEL TRUNKING	EA	£5.89	
MS-V16046	40 x 80mm OPEN SLOT PANEL TRUNKING	EA	£8.70	
MS-V16050	16 x 16mm WHITE MINI SELF ADHESIVE TRUNKING (RUNNING DOWN)	EA	£3.48	
MS-V16051	16 x 16mm WHITE EXTERNAL COUPLER (RUNNING DOWN)	EA	£0.67	
MS-V16052	16 x 16mm WHITE END CAP (RUNNING DOWN)	EA	£0.95	
MS-V16053	16 x 16mm WHITE FLAT ANGLE (RUNNING DOWN)	EA	£0.67	
MS-V16054	16 x 16mm WHITE EXTERNAL ANGLE (RUNNING DOWN)	EA	£0.67	
MS-V16055	16 x 16mm WHITE INTERNAL ANGLE (RUNNING DOWN)	EA	£0.55	
MS-V16056	16 x 16mm WHITE FLAT TEE (RUNNING DOWN)	EA	£0.67	



MS-V17005	20mm WHITE PVC MALE ADAPTOR (RUNNING DOWN)	EA	£0.64	
MS-V17006	20mm WHITE PVC FEMALE ADAPTOR (RUNNING DOWN)	EA	£0.59	
MS-V17007	20mm WHITE PVC MALE BUSH (RUNNING DOWN)	EA	£0.15	
MS-V17008	20mm WHITE PVC LOCKRING (RUNNING DOWN)	EA	£0.50	
MS-V17024	25mm WHITE PVC FEMALE ADAPTOR (RUNNING DOWN)	EA	£0.50	
MS-V17025	25mm WHITE PVC MALE ADAPTOR (RUNNING DOWN)	EA	£1.00	
MS-V17027	25mm WHITE PVC LOCKRING (RUNNING DOWN)	EA	£0.50	
MS-V17040	16mm LOCKRING	EA	£0.14	
MS-V17045	20mm SOLID GALVANISED COUPLING	EA	£0.57	



MS-V17046	20mm CONDUIT NIPPLE	EA	£0.34	
MS-V17048	20mm MALE BRASS BUSH - SHORT	EA	£0.30	
MS-V17049	20mm FEMALE BRASS BUSH	EA	£0.17	
Code	Product	Unit	Std. cost	
MS-V17051	20mm LOCKNUT	EA	£0.08	
MS-V17052	20mm LOCKRING	EA	£0.10	
MS-V17060	25mm GALVANISED CONDUIT COUPLER	EA	£0.40	
MS-V17061	25mm CONDUIT NIPPLE	EA	£0.29	
MS-V17062	25mm MALE BRASS BUSH - LONG	EA	£0.48	
MS-V17063	25mm MALE BRASS BUSH - SHORT	EA	£0.36	











MS-V17064	25mm FEMALE BRASS BUSH	EA	£0.25	
MS-V17066	25mm LOCKNUT STEEL	EA	£0.10	
MS-V17067	25mm LOCKRING STEEL	EA	£0.20	
MS-V17075	32mm GALVANISED CONDUIT COUPLER	EA	£0.83	
MS-V17078	32mm MALE BRASS BUSH - SHORT	EA	£0.95	
MS-V17082	32mm LOCKRING	EA	£0.31	
MS-V17090	1 1/2" CONDUIT COUPLER	EA	£1.02	
MS-V17091	1 1/2" CONDUIT NIPPLE	EA	£1.33	
MS-V17092	1 1/2" MALE BRASS BUSH - LONG	EA	£2.19	
MS-V17093	1 1/2" MALE BRASS BUSH - SHORT	EA	£1.28	





MS-V17094	1 1/2" FEMALE BRASS BUSH	EA	£0.97	
MS-V17096	1 1/2" LOCKNUT	EA	£0.31	
MS-V17097	1 1/2" LOCKRING	EA	£0.34	
MS-V17105	2" GALVANISED COUPLER	EA	£2.73	
MS-V17108	2" BRASS BUSH MALE - SHORT	EA	£1.03	
MS-V17109	2" BRASS BUSH FEMALE	EA	£1.49	
MS-V17112	2" LOCK RING	EA	£0.26	
MS-V17120	1 1/2" - 1 1/4" REDUCER	EA	£0.29	
MS-V17122	25mm - 20mm REDUCER	EA	£1.14	
MS-V17123	20mm - 16mm REDUCER	EA	£0.84	



V19**SURFACE BOXES & PLASTIC PLATES**

MB-V19001	1 GANG WHITE SWITCHED MOULDED SOCKET	EA	£2.06	
MB-V19002	2 GANG RED SWITCHED MOULDED SOCKET (OUTBOARD ROCKERS)	EA	£11.78	
MB-V19004	2 GANG WHITE SWITCHED MOULDED SOCKET (OUTBOARD ROCKERS)	EA	£10.50	
MB-V19005	2 GANG WHITE SWITCHED MOULDED SOCKET	EA	£6.53	
MB-V19009	2 GANG, 13A, METAL CLAD RCD SOCKET	EA	£35.87	
MB-V19011	1 GANG WHITE SWITCHED FUSED CONNECTION UNIT - NEON	EA	£11.86	
MB-V19013	1 GANG WHITE UNSWITCHED FUSED CONNECTION UNIT	EA	£8.38	
MB-V19015	1 GANG WHITE MOULDED BLANK PLATE	EA	£1.89	
MB-V19017	2 GANG WHITE MOULDED BLANK PLATE	EA	£4.60	











MB-V19019	1 GANG SURFACE BOX (20/25mm)	EA	£2.24	
MB-V19021	2 GANG SURFACE BOX (20/25mm)	EA	£3.30	

V20



METAL CLAD SURFACE BOXES & PLATES

MS-V20001	1 GANG METALCLAD SWITCHED SOCKET	EA	£11.97	
MS-V20003	2 GANG METALCLAD SWITCHED SOCKET	EA	£23.00	
MS-V20007	1 GANG METALCLAD SWITCHED FUSED CONNECTION UNIT	EA	£20.00	
MS-V20009	1 GANG METALCLAD UNSWITCHED FUSED CONNECTION UNIT	EA	£10.44	
MS-V20011	1 GANG METALCLAD SWITCHED FUSED CONNECTION UNIT - NEON	EA	£21.57	
MS-V20013	1 GANG METALCLAD BLANK PLATE	EA	£2.61	
MS-V20015	2 GANG METALCLAD BLANK PLATE	EA	£15.90	









MS-V20032	2 GANG SPARE METALCLAD BOX	EA	£10.12	
MS-V20033	2 GANG METALCLAD SWITCHED SOCKET (OUTBOARD ROCKERS)	EA	£27.61	
MS-V20034	1 GANG METALCLAD FRONT PLATE - 1 MODULE (RUNNING DOWN)	EA	£2.66	
MS-V20036	1 GANG METALCLAD FRONT PLATE - 2 MODULES (RUNNING DOWN)	EA	£2.61	
MS-V20038	1 GANG STEEL MOUNTING FRAME - 1 MODULE (RUNNING DOWN)	EA	£1.96	
MS-V20040	1 GANG STEEL MOUNTING FRAME - 2 MODULES (RUNNING DOWN)	EA	£1.74	
MS-V20044	1 MODULE, 2 WAY WHITE 10A GRID SWITCH (RUNNING DOWN)	EA	£3.58	
MS-V20046	1 MODULE, 1 WAY WHITE 20A GRID SWITCH (RUNNING DOWN)	EA	£4.51	
MS-V20048	RED NEON GRID SYSTEM INDICATOR MODULE, 200-250V (RUNNING DOWN)	EA	£10.77	



MS-V20050	AMBER NEON GRID SYSTEM INDICATOR MODULE, 200-250V (RUNNING DOWN)	EA	£15.85	
MS-V20052	GREEN NEON GRID SYSTEM INDICATOR MODULE, 200-250V (RUNNING DOWN)	EA	£13.58	
MS-V20064	1 GANG MODULAR DATA BOX (RUNNING DOWN)	EA	£3.74	

<u>Code</u>	<u>Product</u>	<u>Unit</u>	<u>Std. cost</u>	
-------------	----------------	-------------	------------------	--

<u>V21</u>	<u>FLEXIBLE ARMD CONDUIT & FITTINGS</u>			
MB-V21001	10mm STEEL PVC COVD.CONDUIT	M	£6.49	
MB-V21002	PG7-10mm ADAPTOR - FIXED	EA	£3.70	
MB-V21003	PG7-10mm ADAPTOR - SWIVEL	EA	£2.54	
MB-V21004	PG9-PG7 NICKEL/BRASS REDUCER	EA	£4.78	
MB-V21010	16mm STEEL PVC COVD.CONDUIT	e	£36.70	
MB-V21011	M16 - 16mm ADAPTOR - FIXED	EA	£2.08	







MB-V21012	M16 - 16mm ADAPTOR - SWIVEL	EA	£4.88	
MB-V21013	M20 - 16mm ADAPTOR - FIXED	EA	£5.31	
MB-V21020	20mm STEEL PVC COVD. CONDUIT - 10 METERS	EA	£54.88	
MB-V21021	M20 - 20mm ADAPTOR - FIXED	EA	£6.09	
MB-V21022	M20 - 20mm ADAPTOR - SWIVEL	EA	£2.36	
MB-V21030	10 METRE REEL 25mm PVC COVERED CONDUIT	EA	£98.40	
MB-V21031	M25 - 25mm ADAPTOR - FIXED	EA	£6.59	
MB-V21032	M25 - 25mm ADAPTOR - SWIVEL	EA	£5.31	
MB-V21040	40mm STEEL PVC COVD. CONDUIT	EA	£26.32	
MB-V21041	40mm FIXED MALE ADAPTORS	EA	£14.61	



MB-V21042	40mm SWVL MALE ADAPTR DBL LOCK	EA	£15.71	
-----------	--------------------------------	----	--------	---

V22 **VERIFLEX & KOPEX ACCESSORIES**



MB-V22001	20mm CONDUIT KIT	EA	£16.46	
MB-V22002	10 Metre Reel of 20mm PLIABLE CONDUIT	EA	£56.93	
MB-V22003	20mm FLEX CONDUIT ADAPTOR	EA	£2.20	
MB-V22004	20mm ANGLED FITTING FITS NYLON CONDUIT	EA	£1.73	
MB-V22006	25mm CONDUIT KIT	EA	£36.54	
MB-V22007	(10 Metre Reel of) 25mm FLEXIBLE CONDUIT	RL	£43.60	
MB-V22008	25mm FLEX CONDUIT ADAPTOR	EA	£3.75	
MB-V22009	25mm ANGLED FITTING FITS NYLON CONDUIT	EA	£2.90	



MB-V22012	(10 Metre Reel of) 32mm PVC FLEXIBLE CONDUIT	EA	£87.60	
MB-V22013	32mm ADAPTOR STRAIGHT FITS V22012	EA	£6.15	
MB-V22014	(10 Metre Reel) 32mm ADFLEX BLK CONDUIT ADAPTALOK	EA	£131.00	
MB-V22015	32mm ADFLEX NYLON ADAPTOR	EA	£3.04	
MB-V22018	(Reel of) 50mm ADFLEX CONDUIT	EA	£16.54	
MB-V22019	50mm ADFLEX CONDUIT FITTING	EA	£18.94	

V23









SINGLE & 3-PHASE SOCKET CONNECTORS

MB-V23001	WHITE DURAPLUG 10AMP, 3 PIN	EA	£4.83	
MB-V23002	BT PHONE DATA ADAPTOR (RUNNING DOWN)	EA	£4.05	
MS-V23003	13A MAINS PLUG 13A FUSE	EA	£3.77	







MB-V23004	TELEPHONE EXTENSION LEAD KIT (20MTR) (RUNNING DOWN)	EA	£10.05	
MB-V23005	4 WAY EXTENSION LEAD (2 METRE CABLE)	EA	£6.09	
MB-V23006	3 WAY BT PHONE ADAPTOR (RUNNING DOWN)	EA	£5.22	
MB-V23007	4 WAY EXTENSION BLOCK (NO CABLE)	EA	£5.20	
MB-V23008	4 WAY EXTENSION LEAD (4 METRE CABLE)	EA	£9.13	
MB-V23009	SINGLE WHITE 13A PERMAPLUG	EA	£2.29	
MB-V23010	PHONE EXT BT SCT TO BT PLUG 5MTR (RUNNING DOWN)	EA	£5.22	
MB-V23011	WHITE 13A 2-WAY TRAILING SKT NLTS2W	EA	£4.83	
MB-V23012	PLUG-IN RCD PLUG, BLACK, 230-250V AC, 13A	EA	£29.19	
MB-V23014	20 MTR EXTENSION BT PLUG-SOCKET (RUNNING DOWN)	EA	£7.74	



MB-V24001	CI-PKZO-GM INSL ENC IP54 (EATON SWITCHED ENCLOSURE)	EA	£16.28	
MB-V24003	U-PK70 240V UNDERVOLT RELEASE	EA	£41.55	
MB-V24005	U-PKZO 415V UNDERVOLT RELEASE	EA	£28.32	
MB-V24007	PKZMO 1.6A MOTOR CIRCUIT BREAKER	EA	£83.95	
MB-V24009	PKZMO 2.5A MOTOR CIRCUIT BREAKER	EA	£83.59	
MB-V24011	PKZMO 6.3A MOTOR CIRCUIT BREAKER	EA	£66.22	
MB-V24013	CONTACTOR 25 A 4 POLE 240V COIL & ENCLOSURE	EA	£83.93	
MB-V24030	63A 4 POLE 30mA RCD DIN MOUNT	EA	£157.34	
MB-V24040	EMERGENCY STOP CONTROL STATION (1 POSITION)	EA	£38.42	



MB-V24041	PUSHBUTTON STATION, ENCLOSED START/STOP [IP66]	EA	£24.02	
MB-V24042	K/M M22-A FIXING ADAPTER	EA	£1.58	
MB-V24043	K/M M22-K10 N/O CONTACT ELEMENT	EA	£4.60	
MB-V24044	K/M M22-KC01 N/C CONTACT ELEMENT	EA	£3.77	
MB-V24045	K/M M22-LED230-B LED ELEMENT (BLUE)	EA	£10.02	
MB-V24046	K/M M22-LED230-G LED ELEMENT	EA	£10.02	
MB-V24047	K/M M22-LED230-R LED ELEMENT (RED)	EA	£10.02	
MB-V24048	K/M M22-LED230-W LED ELEMENT	EA	£10.02	
MB-V24049	K/M M22-LED-B LED ELEMENT (BLUE)	EA	£6.73	



MB-V24050	K/M M22-LED-G LED ELEMENT (GREEN)	EA	£9.57	
MB-V24051	K/M M22-LED-R LED ELEMENT (RED)	EA	£6.73	
MB-V24052	K/M M22-LED-W LED ELEMENT (WHITE)	EA	£6.73	
MB-V24053	K/M M22-DRL-R ILLUMINATED PUSH	EA	£11.74	
MB-V24054	K/M M22-DRL-G ILLUMINATED PUSH	EA	£11.74	
MB-V24055	K/M M22-DRL-B ILLUMINATED PUSH	EA	£11.74	
MB-V24056	K/M M22-WRS/K11 KEY OPERATED	EA	£40.54	

Code



Product

Unit

Std. cost

V26

ADAPTABLE BOXES

MB-V26002	100 x 100 x 50mm MOULDED ENCLOSURE	EA	£1.40	
MB-V26003	120 x 80 x 50mm MOULDED ENCLOSURE	EA	£3.04	











MB-V26004	150 x 110 x 70mm MOULDED ENCLOSURE	EA	£3.48	
MB-V26005	190 x 140 x 70mm MOULDED ENCLOSURE	EA	£5.22	
MB-V26006	240 x 190 x 90mm MOULDED ENCLOSURE	EA	£6.09	
MB-V26008	190 x 140 x 140mm MOULDED ENCLOSURE	EA	£13.48	
MB-V26009	300 x 220 x 120mm MOULDED ENCLOSURE	EA	£19.14	
MB-V26010	380 x 300 x 120mm MOULDED ENCLOSURE	EA	£26.10	
MB-V26015	88 x 88 x 53mm BLACK TERMINAL BLOCK, FIVE POLE	EA	£8.55	
MB-V26016	138 x 119 x 70mm GREY TERMINAL BLOCK, FIVE POLE	EA	£6.96	
MB-V26017	98 x 98 x 61mm GREY TERMINAL BLOCK, FIVE POLE	EA	£4.35	
MB-V26020	HAGER METAL ENC 22M GLZD DOOR	EA	£154.43	

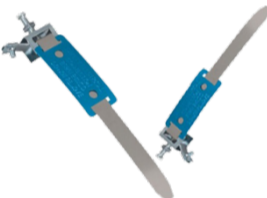

V30



MISCELLANEOUS ELECTRICAL ITEMS

MB-V30001	4 x 6mm SCREWS FOR CONDUIT LIDS	EA	£0.06	
MB-V30008	PLASTERBOARD SCREWS	EA	£0.05	
MB-V30011	40A 4 POLE PLASTIC ISOLATOR	EA	£31.11	
MB-V30015	63A 4 POLE PLASTIC ISOLATOR	EA	£31.82	
MB-V30016	EARTH CLIPS, BS TYPE	EA	£1.91	
MB-V30020	(Multipack of) 6.4 x 0.25mm HEAT SHRINK (RUNNING DOWN)	PCK	£3.91	
MB-V30024	1.6mm HEAT SHRINK SLEEVE 2-1 RATIO 1.22 MTR LENGTH	MTR	£2.52	
MB-V30025	2.4mm HEAT SHRINK SLEEVE 2-1 RATIO 1.22 MTR LENGTH	MTR	£1.60	



MB-V30026	BOX OF 3.2mm HEAT SHRINK SLEEVE 2-1 RATIO	BOX	£15.93	
MB-V30027	4.8mm HEAT SHRINK SLEEVE 2:1 RATIO 1.22 MTR LENGTH	MTR	£2.69	
MB-V30028	6.4mm HEAT SHRINK 2-1 RATIO 1.22 MTR LENGTH	MTR	£4.12	
MB-V30029	BOX OF 9.5mm HEAT SHRINK SLEEVE 2:1 RATIO	BOX	£17.19	
MB-V30030	12.0mm HEAT SHRINK SLEEVE 3:1 RATIO MTR LENGTH	MTR	5.13	
MB-V30031	19.0mm HEAT SHRINK SLEEVE BLK 2:1 RATIO 1.22 MTR LENGTH	MTR	£6.64	
MB-V30032	25.0mm HEAT SHRINK SLEEVE BLK 3:1 RATIO 1.22 MTR LENGTH	MTR	£18.37	
MB-V30065	63A MOD CONTACTOR 240V 4 POLES	EA	£176.57	
MB-V30067	TELEM 16A MOD CONTCTR 240V 2 POLES	EA	£45.10	
MB-V30068	IND RED PLUG 16 AMP 400V 3P+N+E	EA	£5.32	







MB-V30069	RED, 5 PIN 16A 400V NEWLEC SW SCT	EA	£24.36	
MB-V30070	RED 32A 400V SWITCHED INTERLOCK 5PIN	EA	£31.71	
MB-V30071	5 PIN PLUG 32AMP 400V 3P+N+E	EA	£14.21	
MB-V30072	400V 32 A P+N+E WALL SCT SCREWLESS	EA	£16.35	
MB-V30073	16AMP RED TRAILING CONNECTOR 3P+N+E	EA	£9.82	
MB-V30074	32AMP RED TRAILING CONNECTOR 3P+N+E	EA	£20.77	
MB-V30075	PLUG 16A 110V IP44 YELLOW	EA	£2.78	
MB-V30076	PLUG 16A 240V IP44 BLUE	EA	£2.10	
MB-V30077	PLUG 32A 240V IP44 BLUE	EA	£7.97	
MB-V30078	PLUG 63A 415V 3P N+ E RED	EA	£61.36	





MB-V30079	B/G GARAGE KIT ENCLOSURE	EA	£58.80	
MB-V30080	16A 110V YELLOW TRAILING CONNECTOR 2P+E	EA	£5.13	
MB-V30081	16A 240V BLUE TRAILING CONNECTOR 2P+E	EA	£15.13	
MB-V30082	32A 240V BLUE TRAILING CONNECTOR 2P+E	EA	£9.51	
MB-V30083	63A 400V RED TRAILING CONNECTOR 3P N+E	EA	£71.49	
MB-V30087	12.5 x 12.5mm SELF ADHESIVE FEET (SMALL)	SHT	£17.43	
MB-V30088	20 x 20mm SELF ADHESIVE FEET (LARGE)	SHT	£14.98	
MB-V30094	(5 Metre Reel of) 60/40 22SWG SOLDER	EA	£44.71	
MB-V30096	100 x 160mm STRIP BOARD	EA	£2.14	
MB-V30097	119x 455mm STRIP BOARD	EA	£8.38	



MB-V30100	16.0mm Electricians smooth cut holesaw	EA	£19.47	
MB-V30101	20.0mm Electricians smooth cut holesaw	EA	£21.27	
MB-V30102	22.0mm Electricians smooth cut holesaw	EA	£22.87	
MB-V30103	25.0mm Electricians smooth cut holesaw	EA	£21.39	
MB-V30104	32.0mm Electricians smooth cut holesaw	EA	£24.76	

V39 **4mm CONNECTORS**



MB-V39000	RED 4MM ADAPTER UNSHROUDED EXTRA LOW VOLTAGE 15AMP	EA	£5.04	
MB-V39002	4mm BLACK PLUG 24A run down same as V39009	EA	£4.95	

Code **Product** **Unit** **Std. cost**







MB-V39003	4.0MM UNSHROUDED BLACK ADAPTER EXTRA LOW VOLTAGE 15 AMP	EA	5.04	
MB-V39004	STACK SHROUDED 4MM PLUG RED	EA	£2.28	
MB-V39005	MM SAFETY SOCKET 3267I SERIES	EA	£2.07	
MB-V39006	4.0MM BLACK STACK SHROUDED 32 amp	EA	£2.28	
MB-V39007	BLACK 4MM SHROUDED SOCKET	EA	£2.20	
MB-V39008	STACK SHROUDED 4MM PLUG GREY	EA	£2.40	
MB-V39009	4mm GREY SHROUDED SOCKET (FASTON)	EA	£1.96	
MB-V39010	STACK SHROUDED 4MM PLUG BROWN 32A	EA	£2.31	
MB-V39011	4mm BROWN SHROUDED SOCKET (FASTON)	EA	£1.83	





MB-V39012	4mm BLUE STACK SHROUDED PLUG 32A	EA	£2.14	
MB-V39013	4mm BLUE SHROUDED SOCKET 9	EA	£1.85	
MB-V39014	4mm GREEN SHROUDED PLUG	PCK	£4.59	
)			

V42

MISCELLANEOUS ELECTRONIC ITEMS





MB-V42050	PAXOLIN BOARD 6.0MM X 900 X 900MM	EA	£110.79	
MB-V42051	PAXOLIN BOARD 6.0MM X 600 X 600MM	EA	£54.64	
MB-V42052	PAXOLIN BOARD 6.0MM X 300 X 300MM	EA	£14.53	
MB-V42056	PACK OF 2 CABLE TIDY SLEEVES WITH TOOL. REF:MOSOTECH	PCK	£22.09	
MB-V42057	9.5 - 101mm NEUTRAL SPIRAL BINDING	PCK	£6.65	





MB-V42058	36W VERT PCB TIN HDR	EA	£1.47	
MB-V48001	(Pack of 500) 0.5mm BOOTLACE FERRULE WHITE	PCK	£18.14	

V48

BOOTLACE FERRULES

MB-V48002	(Pack of 100) 0.5mm TWIN ENTRY FERRULE WHITE	PCK	£5.85	
MB-V48005	Pack of 500) 0.75mm BOOTLACE FERRULE BLUE	PCK	£5.20	
MB-V48006	(Pack of 500) 0.75mm TWIN ENTRY FERRULE BLUE	PCK	£20.01	
MS-V48009	(Pack of 500) 1.0mm BOOTLACE FERRULE BLUE	PCK	£12.64	
MB-V48010	(Pack of 500) 1.0mm TWIN ENTRY FERRULE RED	PCK	£20.88	

Code

	<u>Product</u>	<u>Unit</u>	<u>Std. cost</u>	
MS-V48013	(Pack of 100) 1.5mm BOOTLACE FERRULE RED	PCK	£1.48	
MB-V48014	(Pack of 100) 1.5mm TWIN ENTRY FERRULE BLACK	PCK	£6.96	

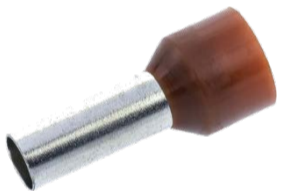

MS-V48017	(Pack of 500) 2.5mm BOOTLACE FERRULE GREY	PCK	£1.95	
MB-V48018	(Pack of 100) 2.5mm TWIN ENTRY FERRULE GREY	PCK	£8.70	
MS-V48021	(Pack of 500) 4.0mm BOOTLACE FERRULE ORANGE	PCK	£17.40	
MB-V48022	(Pack of 100) 4.0mm TWIN ENTRY FERRULE ORANGE	PCK	£10.82	
MS-V48025	(Pack of 100) 6.0mm BOOTLACE FERRULE GREEN	PCK	£8.10	
MB-V48029	(Pack of 100) 10.0mm BOOTLACE FERRULE BROWN	PCK	£4.35	
MS-V48030	(Pack of 100) 10.0mm BOOTLACE FERRULE BROWN	PCK	£12.80	
MB-V48033	(Pack of 100) 16.0mm BOOTLACE FERRULE IVORY	PCK	£3.93	

V49

[DIN RAIL & ACCESSORIES](#)





MS-V49000	35 x 7.5mm SYMMETRICAL DIN RAIL	LEN	£2.08	
MS-V49001	2.5mm INSULATED JUMPER FOR DIN RAIL	EA	£3.70	
MS-V49002	WDU 2.5mm BLUE FEED THRU TERMINAL	EA	£0.93	
MS-V49003	WDU 2.5mm BEIGE FEED THRU TERMINAL	EA	£0.69	
MS-V49004	WPE 2.5mm EARTH TERMINAL	EA	£3.07	
MS-V49005	WAP 2.5/10 END COVER	EA	£0.38	
MS-V49006	4.0mm JUMPER BAR FOR DIN RAIL	EA	£3.49	
MS-V49007	WPE 4.0mm EARTH TERMINAL	EA	£3.16	
MS-V49008	WDU 4.0mm BIEGE FEED THRU TERMINAL	EA	£0.87	
MS-V49009	WDU 4.0mm BLUE FEED THRU TERMINAL	EA	£0.87	



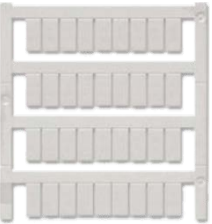

MS-V49011	WDU 2.5mm ORANGE TERMINAL	EA	£1.30	
MS-V49012	WDU 2.5mm BLACK TERMINAL	EA	£1.00	
MS-V49014	6.0mm JUMPER BAR FOR DIN RAIL	EA	£2.97	
MS-V49015	6.0mm TERMINAL FOR TOP HAT RAIL	EA	£1.11	
MS-V49016	WDU 6.0mm BLUE FEED THRU TERMINAL	EA	£1.32	
MS-V49017	WPE 6.0mm GN/YL FEED THRU TERMINAL	EA	£3.27	
MS-V49018	WSI 6.0mm FUSED TERMINALS	EA	£3.48	
MS-V49020	TS35 ENDHOLDER BRACKET KLIPP EW35	EA	£0.81	
MS-V49030	HAGER DIN RAIL CLIP VG01C	EA	£0.80	
MS-V49031	BLANK MARKER CARD WS12/5	EA	£0.08	



MS-V49032	BLANK MARKER CARD WS12/6	EA	£0.07	
MS-V49033	BLANK MARKER CARD WS 12/8	EA	£0.07	
MS-V49040	FUSE HOLDER (DIN RAIL)	EA	£2.15	

V52

SCHNEIDER PRODUCTS

MB-V52000	RED LED PILOT LIGHT 240V PLAIN LENS (XB4BVM4)	EA	£18.04	
MB-V52001	GREEN LED PILOT LIGHT 240V PLAIN LENS (XB4BVM3)	EA	£19.52	
MB-V52002	WHITE LED PILOT LIGHT 240V PLAIN LENS (XB4BVM1)	EA	£19.52	
MB-V52003	YELLOW LED PILOT LIGHT 240V PLAIN LENS (XB4BVM5)	EA	£19.52	
MB-V52004	BLUE LED PILOT LIGHT 240V PLAIN LENS (XB4BVM6)	EA	£10.66	
MB-V52005	RED LED PILOT LIGHT 24V (XB4BVB4)	EA	£10.96	



MB-V52006	GREEN LED PILOT LIGHT 24V (XB4BVB3)	EA	£10.96	
MB-V52007	WHITE LED PILOT LIGHT 24V (XB4BVB1)	EA	£11.84	
MB-V52008	YELLOW LED PILOT LIGHT 24V (XB4BVB5)	EA	£10.94	
MB-V52009	BLUE LED PILOT LIGHT 24V (XB4BVB6)	EA	£30.85	
MB-V52010	YELLOW ILLUMINATED LED PUSHBUTTON (XB4BW35M5)	EA	£27.16	
MB-V52011	GREEN ILLUMINATED LED PUSHBUTTON (XB4BW33M5)	EA	£27.16	
MB-V52012	2 POSITION SELECTOR BLACK TURN SWITCH (ZB4BD2)	EA	£8.14	
Code				
	Product	Unit	std.cost	
MB-V52013	2 POSITION KEY SELECTOR SWITCH (ZB4BG220)	EA	£20.88	
MB-V52014	RED PUSHBUTTON SWITCH (XB4BA42)	EA	£9.08	



MB-V52015	GREEN PUSHBUTTON SWITCH (XB4BA31)	EA	£9.08	
MB-V52016	YELLOW PUSHBUTTON SWITCH (XB4BA51)	EA	£9.90	
MB-V52017	BLUE PUSHBUTTON SWITCH (XB4BA61)	EA	£9.90	
MB-V52018	RED EMERGENCY STOP PUSHBUTTON (XB4BS8445)	EA	£19.95	
MB-V52020	TELEMEC ZBE101 N/O TERMINAL	EA	£4.46	



MB-V52020

TELEMEC ZBE101 N/O TERMINAL

EA

£4.46



MQ-Y01023	(Box of 200) 4.5mm x 50mm SPAX WOODSCREWS	BOX	6.87		
MQ-Y01024	(Box of 100) 4.5mm x 60mm SPAX WOODSCREWS	BOX	25.50		



MQ-Y01030	(Box of 100) 4.2 x 13mm PAN HEAD SELF DRILL	BOX	6.32		
MQ-Y01031	(Box of 100) 4.2 X 20mm PAN HEAD SELF DRILL	BOX	21.00		
MQ-Y01032	(Box of 100) 4.2 x 25mm PAN HEAD SELF DRILL	BOX	9.96		
MQ-Y01050	(Box of 100) CAVITY FIXING KIT SELF DRIVE	BOX	28.90		
MQ-Y01053	(Box of 50) CAVITY FIXING	BOX	15.51		

MQ-Y06 COUNTERSUNK STEEL WOODSCREWS



MQ-Y06055	5" x 25 SPAX POZI SCREW	BOX	15.40		
-----------	-------------------------	-----	-------	--	--

MQ-Y12 RAWL PLUGS

MQ-Y12001	RED PLASTIC RAWLPLUG	EA	0.02		
-----------	----------------------	----	------	---	---

MQ-Y12002	YELLOW PLASTIC RAWLPLUG	EA	0.02		
MQ-Y12003	BLUE PLASTIC RAWLPLUG	EA	0.04		
MQ-Y12004	BROWN PLASTIC RAWLPLUG	EA	0.04		







MQ-Y14 **NAILS (various)**

MQ-Y14006	25.0mm LONG ROUND NAIL	EA	0.02		
MQ-Y14007	50.0mm LONG ROUND NAIL	EA	0.02		
MQ-Y14012	50.0mm LONG OVAL NAIL	EA	0.02		



<u>Code</u>	<u>Product</u>	<u>Unit</u>	<u>Std. cost</u>		
Z	STUDENT PROJECT SUNDRY				
LK-Z01	STUDENT MODEL MAKING INVENTORY				
LK-Z01000	1200 x 1200mm *THIN* CORRUGATED CARD BLANK	EA	£2.20		
LK-Z01001	3mm PLYBOARD LASER BLANK	EA	£4.29		
LK-Z01002	1mm A2 750 GSM GREYBOARD CARD	EA	£0.39		
LK-Z01003	1200 x 1200mm *THICK* CORRUGATED CARD	EA	£2.20		
LK-Z01004	A2 750 MICRONS WHITE CARD	EA	£0.80		
LK-Z01005	3mm A2 GREY CARD	EA	£0.92		
LK-Z01006	0.8mm (1/32") BALSA-1 WOOD SHEET	SHT	£1.62		
LK-Z01007	1.5mm (1/16") BALSA-3 WOOD SHEET	SHT	£1.75		
LK-Z01008	2.5mm (3/32") BALSA-4 WOOD SHEET	SHT	£1.98		
LK-Z01010	3.0mm (1/8") BALSA-5 WOOD SHEET	SHT	£2.19		





LK-Z01012	1:50 PLASTIC FIGURES	PCK	0.92		
LK-Z01013	1:100 PLASTIC FIGURES	PCK	0.30		
LK-Z01015	1:200 PLASTIC FIGURES	PCK	£0.44		
LK-Z01018	4mm LIME DOWELL	EA	0.10		
LK-Z01020	6mm HARDWOOD DOWELL	EA	0.12		
LK-Z01022	8mm HARDWOOD DOWELL	EA	0.30		
LK-Z01024	6.0mm WHITE PAPER STRAWS	PCK	£1.27		
LK-Z01026	4.0mm WHITE PAPER STRAWS	PCK	£0.65		
LK-Z01027	ROLL OF 5 A2 BLEEDPROOF SHEETS	EA	£2.03		
LK-Z01028	ROLL OF 5 A3 BLEEDPROOF SHEETS	EA	£1.08		
LK-Z01029	810 x 450 x 3mm WHITE ACRYLIC BLANK	EA	£11.54		













LK-Z01030	810 x 450 x 3mm BLACK ACRYLIC BLANK	EA	£10.45		
LK-Z01031	2mm ACRLIC LASER BLANK	EA	£10.92		
LK-Z01032	4mm ACRYLIC LASER BLANK	EA	£14.76		
LK-Z01033	6mm ACRYLIC LASER BLANK	EA	£19.18		
LK-Z01034	8mm ACRYLIC LASER BLANK	EA	£23.61		
LK-Z01040	4mm PLASTRUCT H-COLUMN	EA	2.00		
LK-Z01041	4mm PLASTRUCT-I BEAM	EA	£2.00		
LK-Z01050	500mm Roll of MOD MESH MEDIUM	EA	3.15		

LK-Z02 STUDENT DESIGN INVENTORY

LK-Z02000	200mm SPRAY MOUNT AEROSOL	EA	£6.55		
LK-Z02000A	400mm SPRAY MOUNT AEROSOL	EA	£12.16		
LK-Z02001	35ml UHU ALL PURPOSE ADHESIVE	EA	6.03		





LK-Z02002	A3 BLEEDPROOF PAD	EA	£8.50		
LK-Z02003	A2 BLEEDPROOF PAD	EA	£16.07		
LK-Z02004	No3 SCALPAL HANDLE	EA	5.53		
LK-Z02005	10A SCALPAL BLADE	EA	£0.64		
Code	Product	Unit	Std. cost		
LK-Z02007	A2 CLEAR PROJECT BAG AND INSERT	EA	£3.00		
LK-Z02011A	A2 FOAMBOARD	EA	£1.50		
LK-Z02009	A1 CENTRE BOARD GREY	EA	£3.27		
LK-Z02010	3/16" A1 FOAMBOARD BLACK (RUNNING DOWN)	EA	£7.20		
LK-Z02012	A2 90 GSM TRACING PAPER	SHT	£0.27		
LK-Z02013	A1 90 GSM TRACING PAPER	SHT	£0.58		









LK-Z02014	A1 GOLDFINE MOUNTBOARD WHITE	EA	£1.80		
LK-Z02015	A1 GOLDFINE MOUNTBOARD BLACK	EA	£1.80		
LK-Z02016	A4 TECHNIK ART DRAWING PAD	EA	£3.30		
LK-Z02017	PRECISION CHISEL BLADE	PCK	£2.05		
LK-Z02018	DEEP CHISEL BLADE	PCK	£2.05		
LK-Z02019	HEAVY DUTY CARVING BLADE	PCK	£0.50		
LK-Z02021	CARVING BLADE	PCK	£0.80		
LK-Z02022	DETAILING BLADE	PCK	£0.80		
LK-Z02023	HEAVY DUTY DETAILING BLADE	PCK	£1.06		
LK-Z02024	STENCILLING BLADE	PCK	£0.50		





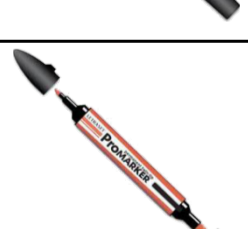







LK-Z02027	SET OF PRECISION CRAFT KNIFE SET	EA	£25.00		
LK-Z02030	POWDER Z CORP	EA	£0.26	 POWDER Z CORP	
LK-Z02031	HP PROTOTYPE PLASTIC	EA	£0.34		









LK-Z03 LETRASET PENS

LK-Z03004	PROMARKER LETRASET PEN RUBY	EA	£1.95		
LK-Z03009	PROMARKER LETRASET PEN BURGUNDY	EA	£1.95		
LK-Z03018	PROMARKER LETRASET PEN CARAMEL	EA	£1.95		
LK-Z03022	PROMARKER LETRASET PEN SANDSTONE	EA	£1.95		
LK-Z03023	PROMARKER LETRASET PEN RAW SIENNA	EA	£1.95		
LK-Z03026	PROMARKER LETRASET PEN MANGO	EA	£1.95		
LK-Z03041	PROMARKER LETRASET PEN VANILLA	EA	£1.95		



LK-Z03055	PROMARKER LETRASET PEN KHAKI	EA	£1.95		
LK-Z03057	PROMARKER LETRASET PEN LIME GREEN	EA	£1.95		
LK-Z03066	PROMARKER LETRASET PEN FOREST GREEN	EA	£1.95		
LK-Z03080	PROMARKER LETRASET PEN PALE PINK	EA	£1.95		
LK-Z03091	PROMARKER LETRASET PEN PUTTY	EA	£1.95		
LK-Z03100	PROMARKER LETRASET PEN COOL GREY 1	EA	£1.95		
LK-Z03101	PROMARKER LETRASET PEN COOL GREY 2	EA	£1.95		
LK-Z03102	PROMARKER LETRASET PEN COOL GREY 3	EA	£1.95		
LK-Z03103	PROMARKER LETRASET PEN COOL GREY 4	EA	£1.95		
LK-Z03104	PROMARKER LETRASET PEN COOL GREY 5	EA	£1.95		
Code	Product	Unit			
LK-Z03105	PROMARKER LETRASET PEN WARM GREY 1	EA	£1.95		

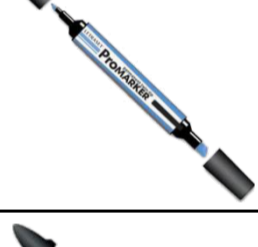

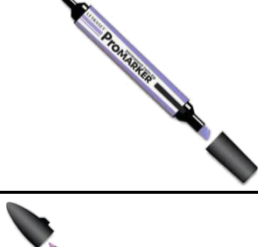
LK-Z03106	PROMARKER LETRASET PEN WARM GREY 2	EA	£1.95		
LK-Z03107	PROMARKER LETRASET PEN WARM GREY 3	EA	£1.95		
LK-Z03108	PROMARKER LETRASET PEN WARM GREY 4	EA	£1.95		
LK-Z03109	PROMARKER LETRASET PEN WARM GREY 5	EA	£1.95		
LK-Z03110	PROMARKER LETRASET PEN BLACK	EA	£1.95		
LK-Z03113	PROMARKER LETRASET PEN TEA GREEN	EA	£1.95		
LK-Z03126	PROMARKER LETRASET PEN CORNFLOWER	EA	£1.95		
LK-Z03129	PROMARKER LETRASET PEN MIDNIGHT BLUE	EA	£1.95		
LK-Z03132	PROMARKER LETRASET PEN POWDER BLUE	EA	£1.95		
LK-Z03141	PROMARKER LETRASET PEN LAVENDER	EA	£1.95		
LK-Z03142	PROMARKER LETRASET PEN ORCHID	EA	£1.95	